



INTERNATIONAL APPLICATION PUBLISHED UNDER THE PATENT COOPERATION TREATY (PCT)

<p>(51) International Patent Classification⁵ : C12N 15/13, 5/10, A61K 39/395 A61K 47/48, 49/02, 43/00</p>	A1	<p>(11) International Publication Number: WO 93/12231 (43) International Publication Date: 24 June 1993 (24.06.93)</p>
<p>(21) International Application Number: PCT/AU91/00583 (22) International Filing Date: 13 December 1991 (13.12.91) (71) Applicant: DOW CHEMICAL (AUSTRALIA) LIMITED [AU/AU]; Forest Corporate Park, 26 Rodborough Road, Frenchs Forest, NSW 2086 (AU). (72) Inventors: MEZES, Peter, S. ; 5101 Oakridge Drive, Midland, MI 48640 (US). RICHARD, Ruth, A. ; 5111 Plainfield Street, Midland, MI 48642 (US). JOHNSON, Kim, S. ; 3765 Freedom Court, Midland, MI 49642 (US). (74) Agent: SPRUSON & FERGUSON; GPO Box 3898, Sydney, NSW 2001 (AU).</p>		<p>(81) Designated States: AT, AU, BB, BG, BR, CA, CH, CS, DE, DK, ES, FI, GB, HU, JP, KP, KR, LK, LU, MG, MN, MW, NL, NO, PL, RO, SD, SE, SU, European patent (AT, BE, CH, DE, DK, ES, FR, GB, GR, IT, LU, MC, NL, SE), OAPI patent (BF, BJ, CF, CG, CI, CM, GA, GN, ML, MR, SN, TD, TG). Published <i>With international search report.</i></p>
<p>(54) Title: COMPOSITE ANTIBODIES OF HUMAN SUBGROUP IV LIGHT CHAIN CAPABLE OF BINDING TO TAG-72</p>		
<p>(57) Abstract</p> <p>This invention concerns a subset of composite Hum4 V_L, V_HαTAG antibody with high affinities to a high molecular weight, tumor-associated sialylated glycoprotein antigen (TAG-72) of human origin. These antibodies have variable regions with (1) V_L segments derived from the human subgroup IV germline gene and (2) a V_H segment which is capable of combining with the V_L to form a three dimensional structure having the ability to bind TAG-72. <i>in vivo</i> methods of treatment and diagnostic assay using these composite antibodies is also disclosed.</p>		

BEST AVAILABLE COPY

FOR THE PURPOSES OF INFORMATION ONLY

Codes used to identify States party to the PCT on the front pages of pamphlets publishing international applications under the PCT.

AT	Austria	FR	France	MR	Mauritania
AU	Australia	GA	Gabon	MW	Malawi
BB	Barbados	GB	United Kingdom	NL	Netherlands
BE	Belgium	GN	Guinea	NO	Norway
BF	Burkina Faso	GR	Greece	NZ	New Zealand
BG	Bulgaria	HU	Hungary	PL	Poland
BJ	Benin	IE	Ireland	PT	Portugal
BR	Brazil	IT	Italy	RO	Romania
CA	Canada	JP	Japan	RU	Russian Federation
CF	Central African Republic	KP	Democratic People's Republic of Korea	SD	Sudan
CG	Congo	KR	Republic of Korea	SE	Sweden
CH	Switzerland	KZ	Kazakhstan	SK	Slovak Republic
CI	Côte d'Ivoire	LJ	Liechtenstein	SN	Senegal
CM	Cameroon	LK	Sri Lanka	SU	Soviet Union
CS	Czechoslovakia	LU	Luxembourg	TD	Chad
CZ	Czech Republic	MC	Monaco	TG	Togo
DE	Germany	MG	Madagascar	UA	Ukraine
DK	Denmark	ML	Mali	US	United States of America
ES	Spain	MN	Mongolia	VN	Viet Nam
FI	Finland				

COMPOSITE ANTIBODIES OF HUMAN SUBGROUP IV LIGHT CHAIN
CAPABLE OF BINDING TO TAG-72

The present invention is directed to the fields of immunology and genetic engineering.

5 The following information is provided for the purpose of making known information believed by the applicants to be of possible relevance to the present invention. No admission is necessarily intended, nor should be construed, that any of the following information constitutes prior art against the present
10 invention.

Antibodies are specific immunoglobulin (Ig) polypeptides produced by the vertebrate immune system in response to challenges by foreign proteins,
15 glycoproteins, cells, or other antigenic foreign substances. The binding specificity of such polypeptides to a particular antigen is highly refined, with each antibody being almost exclusively directed to the particular antigen which elicited it.
20

Two major methods of generating vertebrate antibodies are presently utilized: generation *in situ* by the mammalian B lymphocytes and generation in cell
25 culture by B-cell hybrids. Antibodies are generated in

situ as a result of the differentiation of immature B lymphocytes into plasma cells (see Gough (1981), Trends in Biochem Sci, 6:203 (1981)). Even when only a single antigen is introduced into the immune system for a particular mammal, a uniform population of antibodies does not result, i.e., the response is polyclonal.

The limited but inherent heterogeneity of polyclonal antibodies is overcome by the use of hybridoma technology to create "monoclonal" antibodies in cell cultures by B cell hybridomas (see Kohler and Milstein (1975), Nature, 256:495-497). In this process, a mammal is injected with an antigen, and its relatively short-lived, or mortal, splenocytes or lymphocytes are fused with an immortal tumor cell line. The fusion produces hybrid cells or "hybridomas" which are both immortal and capable of producing the genetically-coded antibody of the B cell.

In many applications, the use of monoclonal antibodies produced in non-human animals is severely restricted where the monoclonal antibodies are to be used in humans. Repeated injections in humans of a "foreign" antibody, such as a mouse antibody, may lead to harmful hypersensitivity reactions, i.e., an anti-idiotypic, or human anti-mouse antibody (HAMA) response, (see Shawler *et al.* (1985), Journal of Immunology, 135:1530-1535. and Sear *et al.*, J. Biol. Resp. Modifiers, 3:138-150).

Various attempts have already been made to manufacture human-derived monoclonal antibodies by using human hybridomas (see Olsson *et al.*, Proc. Natl. Acad. Sci. U.S.A., 77:5429 (1980) and Roder *et al.* (1986), Methods in Enzymology, 121:140-167. Unfortunately,

yields of monoclonal antibodies from human hybridoma cell lines are relatively low compared to mouse hybridomas. In addition, human cell lines expressing immunoglobulins are relatively unstable compared to mouse cell lines, and the antibody producing capability of these human cell lines is transient. Thus, while human immunoglobulins are highly desirable, human hybridoma techniques have not yet reached the stage where human monoclonal antibodies with required antigenic specificities can be easily obtained.

Thus, antibodies of nonhuman origin have been genetically engineered, or "humanized". Humanized antibodies reduce the HAMA response compared to that expected after injection of a human patient with a mouse antibody. Humanization of antibodies derived from nonhumans, for example, has taken two principal forms, i.e., chimerization where non-human regions of immunoglobulin constant sequences are replaced by corresponding human ones (see for example, USP 4,816,567 to Cabilly *et al.*, Genentech) and grafting of complementarity determining regions (CDR) into human framework regions (FR) (see European Patent Office Application (EPO) 0 239 400 to Winter). Some researchers have produced Fv antibodies (USP 4,642,334 to Moore, DNAX) and single chain Fv (SCFV) antibodies (see USP 4,946,778 to Ladner, Genex).

The above patent applications only show the production of antibody fragments in which some portion of the variable domains is coded for by nonhuman gene regions. Humanized antibodies to date still retain various portions of light and heavy chain variable regions of nonhuman origin: the chimeric. Fv and single chain Fv antibodies retain the entire variable region of

nonhuman origin and CDR-grafted antibodies retain CDR of nonhuman origin.

Such nonhuman-derived regions are expected to elicit an immunogenic reaction when administered into a human patient (see Brüggemann *et al.* (1989), J. Exp. Med., 170:2153-2157; and Lo Buglio (1991), Sixth International Conference on Monoclonal Antibody Immunoconjugates for Cancer, San Diego, Ca). Thus, it is most desirable to obtain a human variable region which is capable of binding to a selected antigen.

One known human carcinoma tumor antigen is tumor-associated glycoprotein-72 (TAG-72), as defined by monoclonal antibody B72.3 (see Thor *et al.* (1986) Cancer Res., 46:3118-3124; and Johnson, *et al.* (1986), Cancer Res., 46:850-857). TAG-72 is associated with the surface of certain tumor cells of human origin, specifically the LS174T tumor cell line (American Type Culture Collection (ATCC) No. CL 188), which is a variant of the LS180 (ATCC No. CL 187) colon adenocarcinoma line.

Numerous murine monoclonal antibodies have been developed which have binding specificity for TAG-72. Exemplary murine monoclonal antibodies include the "CC" (colon cancer) monoclonal antibodies, which are a library of murine monoclonal antibodies developed using TAG-72 purified on an immunoaffinity column with an immobilized anti-TAG-72 antibody, B72.3 (ATCC HB-8108) (see EP 394277, to Schiom *et al.*, National Cancer Institute). Certain CC antibodies were deposited with the ATCC: CC49 (ATCC No. HB 9459); CC83 (ATCC No. HB 9453); CC46 (ATCC No. HB 9458); CC92 (ATCC No. HB 9454); CC30 (ATCC NO. HB 9457); CC11 (ATCC No. 9455) and CC15

(ATCC No. HB 9460). Various antibodies of the CC series have been chimerized (see, for example, EPO 0 365 997 to Mezes *et al.*, The Dow Chemical Company).

5 It is thus of great interest to develop
antibodies against TAG-72 containing a light and/or
heavy chain variable region(s) derived from human
antibodies. However, the prior art simply does not
teach recombinant and immunologic techniques capable of
10 routinely producing an anti-TAG-72 antibody in which the
light chain and/or the heavy chain variable regions have
specificity and affinity for TAG-72 and which are
derived from human sequences so as to elicit expectedly
low or no HAMA response. It is known that the function
15 of an immunoglobulin molecule is dependent on its three
dimensional structure, which in turn is dependent on its
primary amino acid sequence. A change of a few or even
one amino acid can drastically affect the binding
function of the antibody can drastically affect its the
20 binding affinity of the antibody, i.e., the resultant
antibodies are generally presumed to be a non-specific
immunoglobulin (NSI), i.e., lacking in antibody
character, (see, for example, USP 4,816,567 to Cabilly
et al., Genentech).

25

Surprisingly, the present invention is capable
of meeting many of these above mentioned needs and
provides a method for supplying the desired antibodies.
For example, in one aspect, the present invention
30 provides a cell capable of expressing a composite
antibody having binding specificity for TAG-72. said
cell being transformed with (a) a DNA sequence encoding
at least a portion of a light chain variable region (VL)
effectively homologous to the human Subgroup IV germline
gene (Hum4 VL); and a DNA sequence segment encoding at

least a portion of a heavy chain variable region (V_H) capable of combining with the V_L into a three dimensional structure having the ability to bind to TAG-72.

5 In another aspect, the present invention provides a composite antibody or antibody having binding specificity for TAG-72, comprising (a) a DNA sequence encoding at least a portion of a light chain (V_L) variable region effectively homologous to the human
10 Subgroup IV germline gene (Hum4 V_L); and a DNA sequence segment encoding at least a portion of a heavy chain variable region (V_H) capable of combining with the V_L into a three dimensional structure having the ability to
15 bind TAG-7.

 The invention further includes the aforementioned antibody alone or conjugated to an imaging marker or therapeutic agent. The invention also
20 includes a composition comprising the aforementioned antibody in unconjugated or conjugated form in a pharmaceutically acceptable, non-toxic, sterile carrier.

 The invention is also directed to a method for
25 *in vivo* diagnosis of cancer which comprises administering to an animal containing a tumor expressing TAG-72 a pharmaceutically effective amount of the aforementioned composition for the *in situ* detection of carcinoma lesions.

30 The invention is also directed to a method for intraoperative therapy which comprises (a) administering to patient containing a tumor expressing TAG-72 a pharmaceutically effective amount of the aforementioned

composition, whereby the tumor is localized, and (b) excising the localized tumors.

5 Additionally, the invention also concerns a process for preparing and expressing a composite antibody. Some of these processes are as follows. A process which comprises transforming a cell with a DNA sequence encoding at least a portion of a light chain variable region (V_L) effectively homologous to the human Subgroup IV germline gene (Hum4 V_L); and a DNA sequence
10 segment encoding at least a portion of a heavy chain variable region (V_H) which is capable of combining with the V_L to form a three dimensional structure having the ability to bind to TAG-72. A process for preparing a composite antibody or antibody which comprises culturing
15 a cell containing a DNA sequence encoding at least a portion of a light chain variable region (V_L) effectively homologous to the human Subgroup IV germline gene (Hum4 V_L); and a DNA sequence segment encoding at least a portion of a heavy chain variable region (V_H)
20 capable of combining with the V_L into a three dimensional structure having the ability to bind to TAG-72 under sufficient conditions for the cell to express the immunoglobulin light chain and immunoglobulin heavy chain. A process for preparing an
25 antibody conjugate comprising contacting the aforementioned antibody or antibody with an imaging marker or therapeutic agent.

30 Description of the Drawings

Figure 1 illustrates a basic immunoglobulin structure.

Figure 2 illustrates the nucleotide sequences of V_HαTAG, CC46 V_H, CC49 V_H, CC83 V_H and CC92 V_H.

Figure 3 illustrates the amino acid sequences of V_HαTAG, CC46 V_H, CC49 V_H, CC83 V_H and CC92 V_H.

5

Figure 4 illustrates the V_H nucleotide and amino acid sequences of antibody B17X2.

10

Figure 5 illustrates the mouse germline J-H genes from pNP9.

Figure 6 illustrates the plasmid map of p49 g1-2.3.

15

Figure 7 illustrates the plasmid map of p83 g1-2.3.

Figure 8 illustrates the entire sequence of HUMVL(+) and HUMVL(-).

20

Figure 9 illustrates the human J4 (HJ4) nucleotide sequence and amino acid sequence.

25

Figure 10 illustrates the nucleotide sequences, and the amino acid sequences of Hum4 V_L, *Cla*I-*Hind*III segment.

30

Figure 11 illustrates a schematic representation of the human germline Subgroup IV V_L gene (Hum4 V_L), as the target for the PCR.

Figure 12 shows the results of agarose gel electrophoresis of the PCR reaction to obtain the Hum4 V_L gene.

Figure 13 illustrates the restriction enzyme map of pRL1000, and precursor plasmids pSV2neo,

pSV2neo-101 and pSV2neo-102. "X" indicates where the *Hind*III site of pSV2neo has been destroyed.

Figure 14 illustrates a polylinker segment made by synthesizing two oligonucleotides: CH(+) and CH(-).

5

Figure 15 illustrates a primer, NEO102SEQ, used for sequencing plasmid DNA from several clones of pSV2neo-102.

10

Figure 16 illustrates an autoradiogram depicting the DNA sequence of the polylinker region in pSV2neo-102.

15

Figure 17 illustrates a partial nucleotide sequence segment of pRL1000.

Figure 18 illustrates the restriction enzyme map of pRL1001.

20

Figure 19 illustrates an autoradiogram of DNA sequence for pRL1001 clones.

Figure 20 illustrates a competition assay for binding to TAG-using a composite Hum4 V_L, V_HαTAG antibody.

25

Figure 21 illustrates a general DNA construction of a single chain, composite Hum4 V_L, V_HαTAG.

30

Figure 22 illustrates the nucleotide sequence and amino acid sequence of SCFV1.

Figure 23 shows the construction of plasmid pCGS515/SCFV1.

Figure 24 shows the construction of plasmid pSCFV31.

Figure 25 shows the construction of E. coli SCFV expression plasmids containing Hum4 VL.

5 Figure 26 shows the DNA sequence and amino acid sequence of Hum4 VL-CC49VH SCFV present in pSCFVUHH.

10 Figure 27 shows the construction plasmid pSCFV UHH and a schematic of a combinatorial library of VH genes with Hum4 VL.

Figure 28 illustrates the nucleotide sequence of FLAG peptide adapter in pATDFLAG.

15 Figure 29 illustrates the construction of pATDFLAG, pHumVL-HumVH (X) and pSC49FLAG.

20 Figure 30 illustrates the nucleotide and amino acid sequences of pSC49FLAG.

Detailed Description of the Invention

Nucleic acids, amino acids, peptides, protective groups, active groups and so on, when
25 abbreviated, are abbreviated according to the IUPAC IUB (Commission on Biological Nomenclature) or the practice in the fields concerned.

30 The basic immunoglobulin structural unit is set forth in Figure 1. The terms "constant" and "variable" are used functionally. The variable regions of both light (V_L) and heavy (V_H) chains determine binding recognition and specificity to the antigen. The constant region domains of light (C_L) and heavy (C_H) chains confer important biological properties such as

antibody chain association, secretion, transplacental mobility, complement binding, binding to Fc receptors and the like.

5 The immunoglobulins of this invention have been developed to address the problems of the prior art. The methods of this invention produce, and the invention is directed to, composite antibodies. By "composite antibodies" is meant immunoglobulins comprising variable regions not hitherto found associated with each other in
10 nature. By, "composite Hum4 VL, VH antibody" means an antibody or immunoreactive fragment thereof which is characterized by having at least a portion of the VL region encoded by DNA derived from the Hum4 VL germline
15 gene and at least a portion of a VH region capable of combining with the VL to form a three dimensional structure having the ability to bind to TAG-72.

20 The composite Hum4 VL, VH antibodies of the present invention assume a conformation having an antigen binding site which binds specifically and with sufficient strength to TAG-72 to form a complex capable of being isolated by using standard assay techniques (e.g., enzyme-linked immunosorbent assay (ELISA),
25 radioimmunoassay (RIA), or fluorescence-activated cell sorter analysis (FACS), immunohistochemistry and the like). Preferably, the composite Hum4 VL, VH antibodies of the present invention have an antigen binding
30 affinity or avidity greater than 10^5 M^{-1} , more preferably greater than 10^6 M^{-1} and most preferably greater than 10^8 M^{-1} . For a discussion of the techniques for generating and reviewing immunoglobulin binding affinities see Munson (1983), Methods Enzymol.,

92:543-577 and Scatchard (1949), Ann. N.Y. Acad. Sci.,
51:660-672.

Human antibody kappa chains have been
classified into four subgroups on the basis of invariant
5 amino acid sequences (see, for example, Kabat *et al.*
(1991), Sequences of Proteins of Immunological Interest
(4th ed.), published by The U.S. Department of Health
and Human Services). There appear to be approximately
10 80 human V_K genes, but only one Subgroup IV V_K gene has
been identified in the human genome (see Klobeck, *et al.*
(1985), Nucleic Acids Research, 13:6516-6528). The
nucleotide sequence of Hum4 V_L is set forth in Kabat *et al.*
al. (1991), *supra*; and Wang *et al.* (1973), Nature, 243:126-
15 127.

It has been found, quite surprisingly, that an
immunoglobulin having a light chain with at least a
portion of the V_L encoded by a gene derived from Hum4 V_L
20 may, if combined with a suitable V_H , have binding
specificity for TAG-72.

The type of J_L gene segment selected is not
critical to the invention, in that it is expected that
25 any J_L , if present, can associate with the Hum4 V_L . The
present invention obviously contemplates the Hum4 V_L in
association with a human J_K sequence. The five human J_K
sequences are set forth in Heiter *et al.* (1982), The
Journal of Biological Chemistry, 357:1516-1522.
30 However, the present invention is not intended to be
limited to the human J_K . The present invention
specifically contemplates the Hum4 V_L in association
with any of the at least six human J_λ genes (see Hollis
et al. (1982), Nature, 296:321-325).

An exemplary technique for engineering the Hum4 V_L with selected J_L segments includes synthesizing a primer having a so-called "wagging tail", that does not hybridize with the target DNA; thereafter, the sequences are amplified and spliced together by overlap extension (see Horton *et al.* (1989), Gene, 77:61-68).

The C_L of the composite Hum4 V_L, V_H antibodies is not critical to the invention. To date, the Hum4 V_L has only been reported as having been naturally rearranged with the single C_k gene (see Heiter *et al.* (1980), Cell, 22:197-207). However, the present invention is not intended to be limited to the C_k light chain constant domain. That is, the C_L gene segment may also be any of the at least six C_λ genes (see Hollis *et al.*, *supra*).

The DNA encoding the heavy chain variable region consists roughly of a heavy chain variable (V_H) gene sequence, a heavy chain diversity (D_H) gene sequence, and a heavy chain joining (J_H) gene sequence.

The present invention is directed to any V_H capable of combining with a light chain variable region effectively homologous to the light chain variable region encoded by the human Subgroup IV germline gene, to form a three dimensional structure having the ability to bind to TAG-72.

The choice of heavy chain diversity (D_H) segment and the heavy chain joining (J_H) segment of the composite Hum4 V_L, V_H antibody are not critical to the present invention. Obviously, human and murine D_H and J_H gene segments are contemplated, provided that a given combination does not significantly decrease binding to

TAG-72. Specifically, when utilizing CC46 V_H, CC49 V_H, CC83 V_H and CC92 V_H, the composite Hum4 V_L, V_H antibody will be designed to utilize the D_H and J_H segments which naturally associated with those V_H of the respective hybridomas (see Figures 2 and 3). Exemplary murine and human D_H and J_H sequences are set forth in Kabat *et al.* (1991), *supra*. An exemplary technique for engineering such selected D_H and J_H segments with a V_H sequence of choice includes synthesizing selected oligonucleotides, annealing and ligating in a cloning procedure (see, Horton *et al.*, *supra*).

In a specific embodiment the composite Hum4 V_L, V_H antibody will be a "composite Hum4 V_L, V_HαTAG antibody", means an antibody or immunoreactive fragment thereof which is characterized by having at least a portion of the V_L region encoded by DNA derived from the Hum4 V_L germline gene and at least a portion of the V_H region encoded by DNA derived from the V_HαTAG germline gene, which is known in the art (see, for example, EPO 0 365 997 to Mezes *et al.*, the Dow Chemical Company). Figure 2 shows the nucleotide sequence of V_HαTAG, and the nucleotide sequences encoding the V_H of the CC46, CC49, CC83 and CC92 antibodies, respectively. Figure 3 shows the corresponding amino acid sequences of V_HαTAG, CC46 V_H, CC49 V_H, CC83 V_H and CC92 V_H.

A comparison of the nucleotide and amino acid sequences of V_HαTAG, CC46 V_H, CC49 V_H, CC83 V_H and CC92 V_H shows that those CC antibodies are derived from V_HαTAG. Somatic mutations occurring during productive rearrangement of the V_H derived from V_HαTAG in a B cell gave rise to some nucleotide changes that may or may not

result in a homologous amino acid change between the productively rearranged hybridomas (see, EPO 0 365 997).

Because the nucleotide sequences of V_HαTAG and Hum4 V_L germline genes have been provided herein, the present invention is intended to include other antibody genes which are productively rearranged from the V_HαTAG germline gene. Other antibodies encoded by DNA derived from V_HαTAG may be identified by using a hybridization probe made from the DNA or RNA of the V_HαTAG or rearranged genes containing the recombined V_HαTAG. Specifically, the probe will include of all or a part of the V_HαTAG germline gene and its flanking regions. By "flanking regions" is meant to include those DNA sequences from the 5' end of the V_HαTAG to the 3' end of the upstream gene, and from 3' end of the V_HαTAG to the 5' end of the downstream gene.

The CDR from the variable region of antibodies derived from V_HαTAG may be grafted onto the FR of selected V_H, i.e., FR of a human antibody (see EPO 0 239 400 to Winter). For example, the cell line, B17X2, expresses an antibody utilizing a variable light chain encoded by a gene derived from Hum4 V_L and a variable heavy chain which makes a stable V_L and V_H combination (see Marsh *et al.* (1985), Nucleic Acids Research, 13:6531-6544; and Polke *et al.* (1982), Immunobiol. 163:95-109. The nucleotide sequence of the V_H chain for B17X2 is shown in Figure 4. The B17X2 cell line is publicly available from Dr. Christine Polke, Universitäts-Kinderklinik, Josef-Schneider-Str. 2, 8700 Würzburg, FRG). B17X2 is directed to N-Acetyl-D-Glucosamine and is not specific for TAG-72.

However, consensus sequences of antibody derived from the CDR1 of V_HαTAG (amino acid residues 31 to 35 of Figure 3) may be inserted into B17X2 (amino acid residues 31 to 37 of Figure 4) and the CDR2 of V_HαTAG (amino residues 50 to 65 of Figure 3) may be inserted into B17X2 (amino acid residues 52 to 67 of Figure 4). The CDR3 may be replaced by any D_H and J_H sequence which does not affect the binding of the antibody for TAG-72 but, specifically, may be replaced by the CDR3 of an antibody having its V_H derived from V_HαTAG, e.g., CC46, CC49, CC83 and CC92. Exemplary techniques for such replacement are set forth in Horton *et al.*, *supra*.

The C_H domains of immunoglobulin heavy chain derived from V_HαTAG genes, for example may be changed to a human sequence by known techniques (see, USP 4,816,567 to Cabilly, Genentech). C_H domains may be of various complete or shortened human isotypes, i.e., IgG (e.g., IgG₁, IgG₂, IgG₃, and IgG₄), IgA (e.g., IgA1 and IgA2), IgD, IgE, IgM, as well as the various allotypes of the individual groups (see Kabat *et al.* (1991), *supra*).

Given the teachings of the present invention, it should be apparent to the skilled artisan that human V_H genes can be tested for their ability to produce an anti-TAG-72 immunoglobulin combination with the Hum4 V_L gene. The V_L may be used to isolate a gene encoding for a V_H having the ability to bind to TAG-72 to test myriad combinations of Hum4 V_L and V_H that may not naturally occur in nature, e.g., by generating a combinatorial library using the Hum4 V_L gene to select a suitable V_H. Examples of these enabling technologies include screening of combinatorial libraries of V_L-V_H combinations using an Fab or single chain antibody

(SCFV) format expressed on the surfaces of fd phage (Clackson, *et al.* (1991), Nature, 352:624-628), or using a λ phage system for expression of Fv's or Fabs (Huse, *et al.* (1989), Science, 246:1275-1281). However, according to the teachings set forth herein, it is now possible to clone SCFV antibodies in *E. coli*, and express the SCFVs as secreted soluble proteins. SCFV proteins produced in *E. coli* that contain a Hum4 V_L gene can be screened for binding to TAG-72 using, for example, a two-membrane filter screening system (Skerra, *et al.* (1991), Analytical Biochemistry, 196:151-155).

The desired gene repertoire can be isolated from human genetic material obtained from any suitable source, e.g., peripheral blood lymphocytes, spleen cells and lymph nodes of a patient with tumor expressing TAG-72. In some cases, it is desirable to bias the repertoire for a preselected activity, such as by using as a source of nucleic acid, cells (source cells) from vertebrates in any one of various stages of age, health and immune response.

Cells coding for the desired sequence may be isolated, and genomic DNA fragmented by one or more restriction enzymes. Tissue (e.g., primary and secondary lymph organs, neoplastic tissue, white blood cells from peripheral blood and hybridomas) from an animal exposed to TAG-72 may be probed for selected antibody producing B cells. Variability among B cells derived from a common germline gene may result from somatic mutations occurring during productive rearrangement.

Generally, a probe made from the genomic DNA of a germline gene or rearranged gene can be used by those

skilled in the art to find homologous sequences from unknown cells. For example, sequence information obtained from Hum4 V_L and V_HαTAG may be used to generate hybridization probes for naturally-occurring rearranged V regions, including the 5' and 3' nontranslated flanking regions. The genomic DNA may include naturally-occurring introns for portions thereof, provided that functional splice donor and splice acceptor regions had been present in the case of mammalian cell sources.

Additionally, the DNA may also be obtained from a cDNA library. mRNA coding for heavy or light chain variable domain may be isolated from a suitable source, either mature B cells or a hybridoma culture, employing standard techniques of RNA isolation. The DNA or amino acids also may be synthetically synthesized and constructed by standard techniques of annealing and ligating fragments (see Jones, *et al.* (1986), Nature, 321:522-525; Reichmann *et al.*, (1988), Nature, 332:323-327; Sambrook *et al.* (1989), *supra* and Merrifield *et al.* (1963), J. Amer. Chem. Soc., 85:2149-2154). Heavy and light chains may be combined *in vitro* to gain antibody activity (see Edelman, *et al.* (1963), Proc. Natl. Acad. Sci. USA, 50:753).

The present invention also contemplates a gene library of V_HαTAG homologs, preferably human homologs of V_HαTAG. By "homolog" is meant a gene coding for a V_H region (not necessarily derived from, or even effectively homologous to, the V_HαTAG germline gene) capable of combining with a light chain variable region effectively homologous to the light chain variable region encoded by the human Subgroup IV germline gene.

to form a three dimensional structure having the ability to bind to TAG-72.

Preferably, the gene library is produced by a primer extension reaction or combination of primer extension reactions as described herein. The V_HαTAG homologs are preferably in an isolated form, that is, substantially free of materials such as, for example, primer extension reaction agents and/or substrates, genomic DNA segments, and the like. The present invention thus is directed to cloning the V_HαTAG-coding DNA homologs from a repertoire comprised of polynucleotide coding strands, such as genomic material containing the gene expressing the variable region or the messenger RNA (mRNA) which represents a transcript of the variable region. Nucleic acids coding for V_HαTAG-coding homologs can be derived from cells producing IgA, IgD, IgE, IgG or IgM, most preferably from IgM and IgG, producing cells.

The V_HαTAG-coding DNA homologs may be produced by primer extension. The term "primer" as used herein refers to a polynucleotide whether purified from a nucleic acid restriction digest or produced synthetically, which is capable of acting as a point of initiation of synthesis when placed under conditions in which synthesis of a primer extension product which is complimentary to a nucleic acid strand is induced, i.e., in the presence of nucleotides and an agent for polymerization such as DNA polymerase, reverse transcriptase and the like, and at a suitable temperature and pH.

Preferably, the V_HαTAG-coding DNA homologs may be produced by polymerase chain reaction (PCR) amplification of double stranded genomic or cDNA, wherein two

primers are used for each coding strand of nucleic acid to be exponentially amplified. The first primer becomes part of the nonsense (minus or complementary) strand and hybridizes to a nucleotide sequence conserved among V_H (plus) strands within the repertoire. PCR is described in Mullis *et al.* (1987), Meth. Enz., 155:335-350; and PCR Technology, Erlich (ed.) (1989). PCR amplification of the mRNA from antibody-producing cells is set forth in Orlandi *et al.* (1989), Proc. Natl. Acad. Sci. USA, 86:3387-3837.

According to a preferred method, the V_H TAG-coding DNA homologs are connected via linker to form a SCFV having a three dimensional structure capable of binding TAG-72. The SCFV construct can be in a V_L -L- V_H or V_H -L- V_L configuration. For a discussion of SCFV see Bird *et al.* (1988), Science, 242:423-426. The design of suitable peptide linker regions is described in U.S. Patent No. 4,704,692 to Ladner *et al.*. Genex.

The nucleotide sequence of a primer is selected to hybridize with a plurality of immunoglobulin heavy chain genes at a site substantially adjacent to the V_H TAG-coding DNA homolog so that a nucleotide sequence coding for a functional (capable of binding) polypeptide is obtained. The choice of a primer's nucleotide sequence depends on factors such as the distance on the nucleic acid from the region coding for the desired receptor, its hybridization site on the nucleic acid relative to any second primer to be used, the number of genes in the repertoire it is to hybridize to, and the like. To hybridize to a plurality of different nucleic acid strands of V_H TAG-coding DNA homolog, the primer

must be a substantial complement of a nucleotide sequence conserved among the different strands.

5 The peptide linker may be coded for by the nucleic acid sequences that are part of the poly-nucleotide primers used to prepare the various gene libraries. The nucleic acid sequence coding for the peptide linker can be made up of nucleic acids attached to one of the primers or the nucleic acid sequence coding for the peptide linker may be derived from 10 nucleic acid sequences that are attached to several polynucleotide primers used to create the gene libraries. Additionally, noncomplementary bases or longer sequences can be interspersed into the primer, 15 provided the primer sequence has sufficient complementarity with the sequence of the strand to be synthesized or amplified to non-randomly hybridize therewith and thereby form an extension product under polynucleotide synthesizing conditions (see Horton *et al.* (1989), Gene, 20 77:61-68).

Exemplary human V_H sequences from which complementary primers may be synthesized are set forth in Kabat *et al.* (1991), *supra*; Humphries *et al.* (1988), 25 Nature, 331:446-449; Schroeder *et al.* (1990), Proc. Natl. Acad. Sci. USA, 87:6146-6150; Berman *et al.* (1988), EMBO Journal, 7:727-738; Lee *et al.* (1987), J. Mol. Biol., 195:761-768); Marks *et al.* (1991), Eur. J. Immunol., 21:985-991; Willems, *et al.* (1991), J. Immunol., 146:3646-30 3651; and Person *et al.* (1991), Proc Natl. Acad. Sci. USA, 88:2432-2436. To produce V_H coding DNA homologs, first primers are therefore chosen to hybridize to (i.e. be complementary to) conserved regions within the J region, CH1 region, hinge region, CH2 region, or CH3 region of immunoglobulin genes and the like. Second primers are

therefore chosen to hybridize with a conserved nucleotide sequence at the 5' end of the V_HαTAG-coding DNA homolog such as in that area coding for the leader or first framework region.

5 Alternatively, the nucleic acid sequences coding for the peptide linker may be designed as part of a suitable vector. As used herein, the term "expression vector" refers to a nucleic acid molecule capable of directing the expression of genes to which they are
10 operatively linked. The choice of vector to which a V_HαTAG-coding DNA homologs is operatively linked depends directly, as is well known in the art, on the functional properties desired, e.g., replication or protein
15 expression, and the host cell (either procaryotic or eucaryotic) to be transformed, these being limitations inherent in the art of constructing recombinant DNA molecules. In preferred embodiments, the eucaryotic cell expression vectors used include a selection marker
20 that is effective in an eucaryotic cell, preferably a drug resistant selection marker.

 Expression vectors compatible with procaryotic cells are well known in the art and are available from
25 several commercial sources. Typical of vector plasmids suitable for procaryotic cells are pUC8, pUC9, pBR322, and pBR329 available from BioRad Laboratories, (Richmond, CA), and pPL and pKK223 available from
30 Pharmacia, (Piscataway, NJ).

 Expression vectors compatible with eucaryotic cells, preferably those compatible with vertebrate cells, can also be used. Eucaryotic cell expression vectors are well known in the art and are available from several commercial sources. Typically, such vectors are

provided containing convenient restriction sites for
insertion of the desired DNA homologue. Typical of
vector plasmids suitable for eucaryotic cells are
pSV2neo and pSV2gpt (ATCC), pSVL and pKSV-10
(Pharmacia), pBPV-1/PML2d (International
5 Biotechnologies, Inc.), and pTDT1 (ATCC).

The use of viral expression vectors to express
the genes of the V_HaTAG-coding DNA homologs is also
contemplated. As used herein, the term "viral
10 expression vector" refers to a DNA molecule that
includes a promoter sequences derived from the long
terminal repeat (LTR) region of a viral genome.
Exemplary phage include λ phage and fd phage (see,
15 Sambrook, *et al.* (1989), Molecular Cloning: A Laboratory
Manual. (2nd ed.), and McCafferty *et al.* (1990), Nature,
6301:552-554.

The population of V_HaTAG-coding DNA homologs
20 and vectors are then cleaved with an endonuclease at
shared restriction sites. A variety of methods have
been developed to operatively link DNA to vectors via
complementary cohesive termini. For instance,
complementary cohesive termini can be engineered into
25 the V_HaTAG-coding DNA homologs during the primer
extension reaction by use of an appropriately designed
polynucleotide synthesis primer, as previously
discussed. The complementary cohesive termini of the
vector and the DNA homolog are then operatively linked
30 (ligated) to produce a unitary double stranded DNA
molecule.

The restriction fragments of Hum4 V_L-coding DNA
and the V_HaTAG-coding DNA homologs population are
randomly ligated to the cleaved vector. A diverse,

random population is produced with each vector having a V_H TAG-coding DNA homolog and Hum4 V_L-coding DNA located in the same reading frame and under the control of the vector's promoter.

5 The resulting single chain construct is then introduced into an appropriate host to provide amplification and/or expression of a composite Hum4 V_L, V_H TAG homolog single chain antibody. Transformation of
10 appropriate cell hosts with a recombinant DNA molecule of the present invention is accomplished by methods that typically depend on the type of vector used. With regard to transformation of procaryotic host cells, see, for example, Cohen *et al.* (1972), Proceedings National
15 Academy of Science. USA. 69:2110; and Sambrook, *et al.* (1989), *supra*. With regard to the transformation of vertebrate cells with retroviral vectors containing rDNAs, see for example, Sorge *et al.* (1984), Mol. Cell. Biol., 4:1730-1737; Graham *et al.* (1973), Virology, 52:456; and Wigler *et al.* (1979), Proceedings National Academy of
20 Sciences. USA, 76:1373-1376.

Exemplary prokaryotic strains that may be used as hosts include *E. coli*, *Bacilli*, and other enterobacteriaceae such as *Salmonella typhimurium*, and various
25 *Pseudomonas*. Common eukaryotic microbes include *S. cerevisiae* and *Pichia pastoris*. Common higher eukaryotic host cells include Sp2/0, VERO and HeLa cells, Chinese hamster ovary (CHO) cell lines, and W138, BHK, COS-7 and
30 MDCK cell lines. Furthermore, it is now also evident that any cell line producing Hum4 V_L, e.g., the B17X2 human cell line, can be used as a recipient human cell line for introduction of a V_H gene complementary to the Hum4 V_L which allows binding to TAG-72. For example, the B17X2 heavy chain may be genetically modified to not

produce the endogenous heavy chain by well known methods; in this way, glycosylation patterns of the antibody produced would be human and not non-human derived.

5 Successfully transformed cells, i.e., cells
containing a gene encoding a composite Hum4 VL, VH_αTAG
homolog single chain antibody operatively linked to a
vector, can be identified by any suitable well known
10 technique for detecting the binding of a receptor to a
ligand. Preferred screening assays are those where the
binding of the composite Hum4 VL, VH_αTAG homolog single
chain antibody to TAG-72 produces a detectable signal,
either directly or indirectly. Screening for productive
15 Hum4 VL and VH_αTAG homolog combinations, or in other
words, testing for effective antigen binding sites to
TAG-72 is possible by using for example, a radiolabeled
or biotinylated screening agent, e.g., antigens, anti-
bodies (e.g., B72.3, CC49, CC83, CC46, CC92, CC30, CC11
20 and CC15) or anti-idiotypic antibodies (see Huse *et al.*,
supra, and Sambrook *et al.*, *supra*); or the use of marker
peptides to the NH₂- or COOH-terminus of the SCFV
construct (see Hopp *et al.* (1988). Biotechnology, 6:1204-
25 1210).

Of course, the Hum4 VL-coding DNA and the
VH_αTAG-coding DNA homologs may be expressed as
individual polypeptide chains (e.g., Fv) or with whole
or fragmented constant regions (e.g., Fab, and F(ab')₂).
30 Accordingly, the Hum4 VL-coding DNA and the VH_αTAG-
coding DNA homologs may be individually inserted into a
vector containing a C_L or C_H or fragment thereof,
respectively. For a teaching of how to prepare suitable

vectors see EPO 0 365 997 to Mezes *et al.*, The Dow Chemical Company.

DNA sequences encoding the light chain and heavy chain of the composite Hum4 VL, VH antibody may be inserted into separate expression vehicles, or into the same expression vehicle. When coexpressed within the same organism, either on the same or the different vectors, a functionally active Fv is produced. When the VH α TAG-coding DNA homolog and Hum4 VL polypeptides are expressed in different organisms, the respective polypeptides are isolated and then combined in an appropriate medium to form a Fv. See Greene *et al.*, Methods in Molecular Biology, Vol. 9, Wickner *et al.* (ed.); and Sambrook *et al.*, *supra*).

Subsequent recombinations can be effected through cleavage and removal of the Hum4 VL-coding DNA sequence to use the VH α TAG-coding DNA homologs to produce Hum4 VL-coding DNA homologs. To produce a Hum4 VL-coding DNA homolog, first primers are chosen to hybridize with (i.e. be complementary to) a conserved region within the J region or constant region of immunoglobulin light chain genes and the like. Second primers become part of the coding (plus) strand and hybridize to a nucleotide sequence conserved among minus strands. Hum4 VL-coding DNA homologs are ligated into the vector containing the VH α TAG-coding DNA homolog, thereby creating a second population of expression vectors. The present invention thus is directed to cloning the Hum4 VL-coding DNA homologs from a repertoire comprised of polynucleotide coding strands, such as genomic material containing the gene expressing the variable region or the messenger RNA (mRNA) which represents a transcript of the variable region. It is

thus possible to use an iterative process to define yet further, composite antibodies, using later generation V_HQTAG-coding DNA homologs and Hum4 V_L-coding DNA homologs.

5 The present invention further contemplates genetically modifying the antibody variable and constant regions to include effectively homologous variable region and constant region amino acid sequences. Generally, changes in the variable region will be made
10 in order to improve or otherwise modify antigen binding properties of the receptor. Changes in the constant region of the antigen receptor will, in general, be made in order to improve or otherwise modify biological
15 properties, such as complement fixation, interaction with membranes, and other effector functions.

"Effectively homologous" refers to the concept that differences in the primary structure of the
20 variable region may not alter the binding characteristics of the antigen receptor. Normally, a DNA sequence is effectively homologous to a second DNA sequence if at least 70 percent, preferably at least 80 percent, and most preferably at least 90 percent of the
25 active portions of the DNA sequence are homologous. Such changes are permissible in effectively homologous amino acid sequences so long as the resultant antigen receptor retains its desired property.

30 If there is only a conservative difference between homologous positions of sequences, they may be regarded as equivalents under certain circumstances. General categories of potentially equivalent amino acids are set forth below, wherein, amino acids within a group may be substituted for other amino acids in that group:

(1) glutamic acid and aspartic acid; (2) hydrophobic amino acids such as alanine, valine, leucine and isoleucine; (3) asparagine and glutamine; (4) lysine, arginine; and (5) threonine and serine.

5 Exemplary techniques for nucleotide replacement include the addition, deletion, or substitution of various nucleotides, deletion or substitution of various nucleotides, provided that the proper reading frame is maintained. Exemplary techniques include using
10 polynucleotide-mediated, site-directed mutagenesis, i.e., using a single strand as a template for extension of the oligonucleotide to produce a strand containing the mutation (see Zoller *et al.* (1982), Nuc. Acids Res.,
15 10:6487-6500; Norris *et al.* (1983), Nuc. Acids Res., 11:5103-5112; Zoller *et al.* (1984), DNA, 3:479-488; Kramer *et al.* (1982), Nuc. Acids Res., 10:6475-6485 and polymerase chain reaction, i.e., exponentially amplifying DNA *in vitro* using sequence specified oligo-
20 nucleotides to incorporate selected changes (see PCR Technology: Principles and Applications for DNA Amplification, Erlich, (ed.) (1989); and Horton *et al. supra*).

25 Further, the antibodies may have their constant region domain modified, i.e., the C_L, CH₁, hinge, CH₂, CH₃ and/or CH₄ domains of an antibody polypeptide chain may be deleted, inserted or changed (see EPO 327 378 A1 to Morrison *et al.*, the Trustees of Columbia University;
30 USP 4,642,334 to Moore *et al.*, DNAX; and USP 4,704,692 to Ladner *et al.*, Genex).

Once a final DNA construct is obtained, the composite Hum4 V_L, V_H antibodies may be produced in large quantities by injecting the host cell into the

peritoneal cavity of pristane-primed mice, and after an appropriate time (about 1-2 weeks), harvesting ascites fluid from the mice, which yields a very high titer of homogeneous composite Hum4 VL, VH antibodies, and isolating the composite Hum4 VL, VH antibodies by methods well known in the art (see Stramignoni. *et al.* (1983), Intl. J. Cancer, 31:543-552). The host cell are grown *in vivo*, as tumors in animals, the serum or ascites fluid of which can provide up to about 50 mg/mL of composite Hum4 VL, VH antibodies. Usually, injection (preferably intraperitoneal) of about 10^6 to 10^7 histocompatible host cells into mice or rats will result in tumor formation after a few weeks. It is possible to obtain the composite Hum4 VL, VH antibodies from a fermentation culture broth of procaryotic and eucaryotic cells, or from inclusion bodies of *E. coli* cells (see Buckholz and Gleeson (1991), BIO/TECHNOLOGY, 9:1067-1072. The composite Hum4 VL, VH antibodies can then be collected and processed by well-known methods (see generally, Immunological Methods, vols. I & II, eds. Lefkovits, I. and Pernis, B., (1979 & 1981) Academic Press, New York, N.Y.: and Handbook of Experimental Immunology, ed. Weir, D., (1978) Blackwell Scientific Publications, St. Louis, MO.)

The composite Hum4 VL, VH antibodies can then be stored in various buffer solutions such as phosphate buffered saline (PBS), which gives a generally stable antibody solution for further use.

Uses

The composite Hum4 VL, VH antibodies provide unique benefits for use in a variety of cancer treatments. In addition to the ability to bind

specifically to malignant cells and to localize tumors and not bind to normal cells such as fibroblasts, endothelial cells, or epithelial cells in the major organs, the composite Hum4 V_L, V_H antibodies may be used to greatly minimize or eliminate ANHA responses thereto. Moreover, TAG-72 contains a variety of epitopes and thus it may be desirable to administer several different composite Hum4 V_L, V_H antibodies which utilize a variety of V_H in combination with Hum4 V_L.

Specifically, the composite Hum4 V_L, V_H antibodies are useful for, but not limited to, *in vivo* and *in vitro* uses in diagnostics, therapy, imaging and biosensors.

The composite Hum4 V_L, V_H antibodies may be incorporated into a pharmaceutically acceptable, non-toxic, sterile carrier. Injectable compositions of the present invention may be either in suspension or solution form. In solution form the complex (or when desired the separate components) is dissolved in a pharmaceutically acceptable carrier. Such carriers comprise a suitable solvent, preservatives such as benzyl alcohol, if needed, and buffers. Useful solvents include, for example, water, aqueous alcohols, glycols, and phosphonate or carbonate esters. Such aqueous solutions generally contain no more than 50 percent of the organic solvent by volume.

Injectable suspensions require a liquid suspending medium, with or without adjuvants, as a carrier. The suspending medium can be, for example, aqueous polyvinyl-pyrrolidone, inert oils such as vegetable oils or highly refined mineral oils, or aqueous carboxymethylcellulose. Suitable physio-

logically-acceptable adjuvants, if necessary to keep the complex in suspension, may be chosen from among thickeners such as carboxymethylcellulose, polyvinylpyrrolidone, gelatin, and the alginates. Many surfactants are also useful as suspending agents, for example, lecithin, alkylphenol, polyethylene oxide adducts, naphthalenesulfonates, alkylbenzenesulfonates, and the polyoxyethylene sorbitan esters. Many substances which effect the hydrophobicity, density, and surface tension of the liquid suspension medium can assist in making injectable suspensions in individual cases. For example, silicone antifoams, sorbitol, and sugars are all useful suspending agents.

Methods of preparing and administering conjugates of the composite Hum4 VL, VH antibody, and a therapeutic agent are well known to or readily determined. Moreover, suitable dosages will depend on the age and weight of the patient and the therapeutic agent employed and are well known or readily determined.

Conjugates of a composite Hum4 VL, VH antibody and an imaging marker may be administered in a pharmaceutically effective amount for the *in vivo* diagnostic assays of human carcinomas, or metastases thereof, in a patient having a tumor that expresses TAG-72 and then detecting the presence of the imaging marker by appropriate detection means.

Administration and detection of the conjugates of the composite Hum4 VL, VH antibody and an imaging marker, as well as methods of conjugating the composite Hum4 VL, VH antibody to the imaging marker are accomplished by methods readily known or readily determined. The dosage of such conjugate will vary

depending upon the age and weight of the patient. Generally, the dosage should be effective to visualize or detect tumor sites, distinct from normal tissues. Preferably, a one-time dosage will be between 0.1 mg to 200 mg of the conjugate of the composite Hum4 V_L anti-
5 body and imaging marker per patient.

Examples of imaging markers which can be conjugated to the composite Hum4 V_L antibody are well known and include substances which can be detected by
10 diagnostic imaging using a gamma scanner or hand held gamma probe, and substances which can be detected by nuclear magnetic resonance imaging using a nuclear magnetic resonance spectrometer.

15 Suitable, but not limiting, examples of substances which can be detected using a gamma scanner include ¹²⁵I, ¹³¹I, ¹²³I, ¹¹¹In, ¹⁰⁵Rh, ¹⁵³Sm, ⁶⁷Cu, ⁶⁷Ga, ¹⁶⁶Ho, ¹⁷⁷Lu, ¹⁸⁶Re, ¹⁸⁸Re and ^{99m}Tc. An example
20 of a substance which can be detected using a nuclear magnetic resonance spectrometer is gadolinium.

Conjugates of a composite Hum4 V_L, V_H anti-
bodies and a therapeutic agent may be administered in a
25 pharmaceutically effective amount for the *in vivo* treatment of human carcinomas, or metastases thereof, in a patient having a tumor that expresses TAG-72. A "pharmaceutically effective amount" of the composite
Hum4 V_L antibody means the amount of said antibody
30 (whether unconjugated, i.e., a naked antibody, or conjugated to a therapeutic agent) in the pharmaceutical composition should be sufficient to achieve effective binding to TAG-72.

Exemplary naked antibody therapy includes, for example, administering heterobifunctional composite Hum4 VL, VH antibodies coupled or combined with another antibody so that the complex binds both to the carcinoma and effector cells, e.g., killer cells such as T cells, or monocytes. In this method, the composite Hum4 VL antibody-therapeutic agent conjugate can be delivered to the carcinoma site thereby directly exposing the carcinoma tissue to the therapeutic agent. Alternatively, naked antibody therapy is possible in which antibody dependent cellular cytotoxicity or complement dependent cytotoxicity is mediated by the composite Hum4 VL antibody.

Examples of the antibody-therapeutic agent conjugates which can be used in therapy include antibodies coupled to radionuclides, such as ^{131}I , ^{90}Y , ^{105}Rh , ^{47}Sc , ^{67}Cu , ^{212}Bi , ^{211}At , ^{67}Ga , ^{125}I , ^{186}Re , ^{188}Re , ^{177}Lu , $^{99\text{m}}\text{Tc}$, ^{153}Sm , ^{123}I and ^{111}In ; to drugs, such as methotrexate, adriamycin; to biological response modifiers, such as interferon and to toxins, such as ricin.

Methods of preparing and administering conjugates of the composite Hum4 VL, VH antibodies and a therapeutic agent are well known or readily determined. The pharmaceutical composition may be administered in a single dosage or multiple dosage form. Moreover, suitable dosages will depend on the age and weight of the patient and the therapeutic agent employed and are well known or readily determined.

Composite Hum4 VL, VH antibodies, and particularly composite Hum4 VL, VH single chain antibodies thereof, are particularly suitable for radioimmunoguided

surgery (RIGS). In RIGS, an antibody labeled with an imaging marker is injected into a patient having a tumor that expresses TAG-72. The antibody localizes to the tumor and is detected by a hand-held gamma detecting probe (GDP). The tumor is then excised (see Martin *et al.* (1988), Amer. J. Surg., 156:386-392; and Martin *et al.* (1986), Hybridoma, 5:S97-S108). An exemplary GDP is the Neoprobe™ scanner, commercially available from Neoprobe Corporation, Columbus, OH. The relatively small size and human character of the composite Hum4 VL, VH single chain antibodies will accelerate whole body clearance and thus reduce the waiting period after injection before surgery can be effectively initiated.

Administration and detection of the composite Hum4 VL, VH antibody-imaging marker conjugate may be accomplished by methods well-known or readily determined.

The dosage will vary depending upon the age and weight of the patient, but generally a one time dosage of about 0.1 to 200 mg of antibody-marker conjugate per patient is administered.

EXAMPLES

5 The following nonlimiting examples are merely for illustration of the construction and expression of composite Hum4 VL, VH antibodies. All temperatures not otherwise indicated are Centigrade. All percents not otherwise indicated are by weight.

Example I

10 CC49 and CC83 were isolated from their respective hybridomas using pNP9 as a probe (see Figure 5). CC49 VH was obtained from p49 g1-2.3 (see Figure 6) and CC83 VH was obtained from p83 g1-2.3 (see Figure 7),
15 following the procedures set forth in EPO 0 365 997.

DNA encoding an antibody light chain was isolated from a sample of blood from a human following the protocol of Madisen *et.al.* (1987), Am. J. Med. Genet.,
20 27:379-390) with several modifications. Two 5 ml purple-cap Vacutainer tubes (containing EDTA as an anticoagulant) were filled with blood and stored at ambient temperature for 2 hours. The samples were transferred to two 4.5 mL centrifuge tubes. To each
25 tube was added 22.5 mL of filter-sterilized erythrocyte lysate buffer (0.155 M NH₄Cl and 0.17 M Tris, pH 7.65, in a volume ratio of 9:1), and incubated at 37°C for 6.5 minutes. The tubes became dark red due to the lysed red
30 blood cells. The samples were centrifuged at 9°C for 10 minutes, using an SS-34 rotor and a Sorvall centrifuge at 5,300 revolutions per minute (rpm) (~3,400 X g). The resulting white cell pellets were resuspended in 25 mL of 0.15 M NaCl solution. The white blood cells were then centrifuged as before. The pellets were resuspended in 500 µL of 0.15 M NaCl and transferred to

1.5 mL microcentrifuge tubes. The cells were pelleted again for 3 minutes, this time in the microcentrifuge at 3,000 rpm. Very few red blood cells remained on the pellet. After the supernatants were decanted from the two microcentrifuge tubes, 0.6 mL high TE buffer (100 mM Tris, pH 8.0) was added. The tubes were hand-shaken for 10 and 15 minutes. The resulting viscous solution was extracted with phenol, phenol-chloroform and finally with just chloroform as described in Sambrook *et al.*, *supra*. To 3.9 mL of pooled extracted DNA solution was added 0.4 mL NaOAc (3 M, pH 5), and 10 mL 100 percent ethanol. A white stringy precipitate was recovered with a yellow pipette tip, transferred into a new Eppendorf tube, washed once with 70 percent ethanol, and finally washed with 100 percent ethanol. The DNA was dried *in vacuo* for 1 minute and dissolved in 0.75 mL deionized water. A 20 μ L aliquot was diluted to 1.0 mL and the OD 260 nm value was measured and recorded. The concentration of DNA in the original solution was calculated to be 0.30 mg/mL.

Oligonucleotides (oligos) were synthesized using phosphoramidite chemistry on a 380A DNA synthesizer (Applied Biosystems, Foster, CA) starting on 0.2 μ M solid support columns. Protecting groups on the final products were removed by heating in concentrated ammonia solution at 55°C for 12 hours. Crude mixtures of oligonucleotides (approximately 12 OD 260 nm units) were applied to 16 percent polyacrylamide-urea gels and electrophoresed. DNA in the gels was visualized by short wave UV light. Bands were cut out and the DNA eluted by heating the gel pieces to 65°C for 2 hours. Final purification was achieved by application of the eluted DNA solution onto C-18 Sep-Pac™ columns

(Millipore) and elution of the bound oligonucleotide with a 60 percent methanol solution. The pure DNA was dissolved in deionized distilled water (ddH₂O) and quantitated by measuring OD 260 nm.

5 A GeneAmp™ DNA amplification kit (Cetus Corp., Emeryville, CA) was used to clone the Hum4 V_L germline gene by the PCR which was set up according to the manufacturer's directions. A thermal cycler was used
10 for the denaturation (94 °C), annealing (45 °C) and elongation (72 °C) steps. Each of the three steps in a cycle were carried out for 4 minutes; there was a total of 30 cycles.

15 Upstream of the regulatory sequences in the Hum4 V_L germline gene, there is a unique *Cla* I restriction enzyme site. Therefore, the 5' end oligonucleotide for the PCR technique, called HUMVL(+) (Figure 8), was designed to include this *Cla* I site.

20 The 3' end oligonucleotide, called HUMVL(-) (Figure 8), contained a unique *Hind* III site; sufficient mouse intron sequence past the splicing site to permit an effective splice donor function; a human J4 sequence
25 contiguous with the 3' end of the V_L exon of Hum4 V_L to complete the CDR3 and FR4 sequences of the V_L domain (see Figures 9 and 10); nucleotides to encode a tyrosine residue at position 94 in CDR3; and 29 nucleotides close to the 3' end of the V_L exon of Hum4 V_L (shown
30 underlined in the oligonucleotide HUMVL(-) in Figure 8) to anneal with the human DNA target. In total, this 3' end oligonucleotide for the PCR was 98 bases long with a non-annealing segment (a "wagging tail") of 69 nucleotides. A schematic of the Hum4 V_L gene target and

the oligonucleotides used for the PCR are shown in Figure 11.

5 A PCR reaction was set up with 1 μ g of total human DNA in a reaction volume of 100 μ L. Primers HUMVL(-) and HUMVL(+) were each present at an initial concentration of 100 pmol. Prior to the addition of *Taq* polymerase (2.5 units/reaction) 100 μ Ls of mineral oil were used to overlay the samples. Control samples were set up as outlined below. The samples were heated to 95 $^{\circ}$ C for 3 minutes. When the PCR was complete, 20 μ L samples were removed for analysis by agarose gel electrophoresis.

15 Based on the known size of the Hum4 VL DNA fragment to be cloned, and the size of the oligonucleotides used to target the gene, a product of 1099 bp was expected. A band corresponding to this size was obtained in the reaction (shown in lane 7, Figure 12).

20 To prepare a plasmid suitable for cloning and subsequently expressing the Hum4 VL gene, the plasmid pSV2neo was obtained from ATCC and subsequently modified. pSV2neo was modified as set forth below (see Figure 13).

30 The preparation of pSV2neo-101 was as follows. Ten micrograms of purified pSV2neo were digested with 40 units of *Hind* III at 37 $^{\circ}$ C for 1 hour. The linearized plasmid DNA was precipitated with ethanol, washed, dried and dissolved in 10 μ L water. Two microliters each of 10 mM dATP, dCTP, dGTP and dTTP were added, as well as 2 μ L of 10X ligase buffer. Five units (1 μ L) of DNA polymerase I were added to make blunt the *Hind* III

5 sticky ends. The reaction mixture was incubated at room temperature for 30 minutes. The enzyme was inactivated by heating the mixture to 65°C for 15 minutes. The reaction mixture was phenol extracted and ethanol precipitated into a pellet. The pellet was dissolved in 20 µl deionized, distilled water. A 2 µl aliquot (ca. 1 µg) was then added to a standard 20 µL ligation reaction, and incubated overnight at 4 °C.

10 Competent *E. coli* DH1 cells were transformed with 1 µL and 10 µL aliquots of the ligation mix (Invitrogen, San Diego, CA) according to the manufacturer's directions. Ampicillin resistant colonies were obtained on LB plates containing 100 µg/mL ampicillin. Selected clones grown in 2.0 mL overnight cultures were prepared, 15 samples of plasmid DNA were digested with *Hind* III and *Bam* HI separately, and a correct representative clone selected.

20 The resulting plasmid pSV2neo-101 was verified by size mapping and the lack of digestion with *Hind* III.

A sample of DNA from pSV2neo-10 mini-lysate was prepared by digesting with 50 units of *Bam* HI at 37°C for 2 hours. The linearized plasmid was purified from a 25 4 percent DNA polyacrylamide gel by electroelution. The DNA ends were made blunt by filling in the *Bam* HI site using dNTPs and Klenow fragment, as described earlier for the *Hind* III site of pSV2 neo-101.

30 A polylinker segment containing multiple cloning sites was incorporated at the *Bam* HI site of pSV2neo-101 to create pSV2neo-102. Equimolar amounts of two oligonucleotides, CH(+) and CH(-) (shown in Figure 14) were annealed by heating for 3 minutes at 90 °C and

cooling to 50 °C. Annealed linker DNA and blunt ended pSV2neo-101 were added, in a 40:1 molar volume to a standard 20 µL ligation reaction. *E.coli* DH1 was transformed with 0.5 µL and 5 µL aliquots of the ligation mixture (Invitrogen). Twelve ampicillin resistant colonies were selected for analysis of plasmid DNA to determine whether the linker had been incorporated.

A *Hind* III digest of mini-lysate plasmid DNA revealed linker incorporation in six of the clones. The plasmid DNA from several clones was sequenced, to determine the number of linker units that were blunt-end ligated to pSV2neo-101 as well as the relative orientation(s) with the linker. Clones for sequencing were selected on the basis of positive digestion with *Hind* III.

A Sequenase™ sequencing kit (United States Biochemical Corp, Cleveland, OH) was used to sequence the DNA. A primer, NEO102SEQ, was used for sequencing and is shown in Figure 15. It is complementary to a sequence located upstream from the *Bam*HI site in the vector. Between 3 µg and 5 µg of plasmid DNA isolated from *E.coli* mini-lysates were used for sequencing. The DNA was denatured and precipitated prior to annealing, as according to the manufacturer's instructions. Electrophoresis was carried out at 1500 volts; gels were dried prior to exposure to Kodak X-ray film. Data was processed using Hitachi's DNASIS™ computer program.

From the DNA sequence data of 4 clones analyzed (see photograph of autoradiogram - Figure 16), compared to the expected sequence in Figure 14, two clones having

the desired orientation were obtained. A representative clone was selected and designated pSV2neo-102.

A human Cx gene was inserted into pSV2neo-102 to form pRL1000. The human Cx DNA was contained in a 5.0 kb *Hind* III-*Bam* HI fragment (Hieter *et al.* (1980), Cell, 22:197-207).

A 3 µg sample of DNA from a mini-lysate of pSV2neo-102 was digested with *Bam* HI and *Hind* III. The vector DNA was separated from the small *Bam* HI-*Hind* III linker fragment, generated in the reaction, by electrophoresis on a 3.75 percent DNA polyacrylamide gel. The desired DNA fragment was recovered by electroelution. A pBR322 clone containing the 5.0 kb *Hind* III-*Bam* HI fragment of the human Cx gene (see Hieter *et al.*, *supra*) was designated phumCx. The 5.0 kb *Hind* III-*Bam* HI fragment was ligated with pSV2neo-102r and introduced into *E. coli* DH1 (Invitrogen). Ampicillin resistant colonies were screened and a clone containing the human Cx gene was designated pRL1000.

Finally, pRL1000 clones were screened by testing mini-lysate plasmid DNA from *E. coli* with *Hind* III and *Bam* HI. A clone producing a plasmid which gave 2 bands, one at 5.8 Kb (representing the vector) and the other at 5.0 kb (representing the human Cx insert) was selected. Further characterization of pRL1000 was achieved by sequencing downstream from the *Hind* III site in the intron region of the human Cx insert. The oligonucleotide used to prime the sequencing reaction was NEO102SEQ (Figure 15). Two hundred and seventeen bases were determined (see Figure 17). A new oligonucleotide corresponding to the (-) strand near the *Hind* III site (shown in Figure 17) was synthesized so

that clones, containing the HHum4 VL gene that were cloned into the *Cla* I and *Hind* III sites in pRL1000 (see Figure 13), could be sequenced.

5 A *Cla* I-*Hind* III DNA fragment containing Hum4 VL obtained by PCR was cloned into the plasmid vector pRL1000. DNA of pRL1000 and the Hum4 VL were treated with *Cla* I and *Hind* III and the fragments were gel purified by electrophoresis, as described earlier.

10 The pRL1000 DNA fragment and fragment containing Hum4 VL gene were ligated, and the ligation mixture used to transform *E.coli* DH1 (Invitrogen), following the manufacturer's protocol. Ampicillin resistant clones were screened for the presence of the
15 Hum4 VL gene by restriction enzyme analysis and a representative clone designated pRL1001 (shown in Figure 18).

20 Four plasmids having the correct *Cla* I-*Hind* III restriction pattern were analyzed further by DNA sequencing of the insert region (see Figure 19). *Hind* III Cx(-) (shown in Figure 17), HUMLIN1(-) (shown in Figure 10), HUMLIN2(-) (shown in Figure 10) were used as
25 the sequencing primers. Two out of the four plasmids analyzed had the expected sequence in the coding regions (Figure 19, clones 2 and 9).

30 Clone 2 was chosen and used for generating sufficient plasmid DNA for cell transformations and other analysis. This plasmid was used for sequencing through the Hum4 VL, and the upstream region to the *Cla* I site. Only one change at nucleotide position 83 from a C to a G (Figure 10) was observed, compared to a

published sequence (Klobeck *et al.* (1985), *supra*). The DNA sequence data also indicates that the oligonucleotides used for the PCR had been correctly incorporated in the target sequence.

5 The Biorad Gene Pulser™ apparatus was used to transfect Sp2/0 cells with linearized plasmid DNAs containing the light or heavy chain constructs. The Hum4 VL was introduced in Sp2/0 cells along with
10 corresponding heavy chains by the co-transfection scheme indicated in Table 1.

Table 1

Cell Line Designation	DNA Added		
	L Chain pRL1001	H Chain p49 gl-2.3	H Chain p83 gl-2.3
MP1-44H	20 µg	15 µg	0 µg
MP1-84H	20 µg	0 µg	15 µg

15 A total of 8.0×10^6 Sp2/0 cells were washed in sterile PBS buffer (0.8 mL of 1×10^7 viable cells/mL) and held on ice for 10 minutes. DNA of pRL1001,
25 linearized at the *Cla* I site, and the DNA of either p49 gl-2.3 or p83 gl-2.3, linearized at their respective *Nde* I sites, were added, in sterile PBS, to the cells (see protocol - Table 2) and held at 0 °C for a further 10
30 minutes. A single 200 volt, 960 µF electrical pulse lasting between 20 and 30 milliseconds was used for the electroporation. After holding the perturbed cells on ice for 5 minutes, 25 mL of RPMI medium with 10 percent fetal calf serum were introduced, and 1.0 mL samples aliquoted in a 24 well tissue culture plate. The cells were incubated at 37 °C in a 5 percent CO₂ atmosphere.

After 48 hours, the media was exchanged with fresh selection media, now containing both 1 mg/mL Geneticin (G418) (Difco) and 0.3 µg/ml mycophenolic acid/gpt medium. Resistant cells were cultured for 7-10. days.

5 Supernatants from wells having drug resistant colonies were tested on ELISA plates for activity against TAG-72. A roughly 10 percent pure TAG-72 solution prepared from LS147T tumor xenograft cells was
10 chloride microtitration plates (Dynatech Laboratories, Inc.). Wells were air-dried overnight, and blocked the next day with 1 percent BSA. Supernatant samples to be tested for anti-TAG-72 antibody were added to the washed
15 wells and incubated for between 1 and 2 hours at 37 °C. Alkaline phosphatase labeled goat anti-human IgG (diluted 1:250) (Southern Biotech Associates, Birmingham, AL) was used as the probe antibody. Incubation was for 1 hour. The substrate used was p-
20 nitrophenylphosphate. Color development was terminated by the addition of 1.0 N NaOH. The plates were read spectrophotometrically at 405 nm and 450 nm, and the values obtained were 405 nm-450 nm.

25 Those samples producing high values in the assay were subcloned from the original 24 well plate onto 96 well plates. Plating was done at a cell density of half a cell per well (nominally 50 cells) to get pure
30 monoclonal cell lines. Antibody producing cell lines were frozen down in media containing 10 percent DMSO.

Two cell lines were procured having the designations: MP1-44H and MP1-84H. MP1-44H has the chimeric CC49 γ1 heavy chain with the Hum4 V_L light

chain; and MP1-84H has the chimeric CC83 g1 heavy chain with the HumVkIV light chain.

5 A 1.0 L spinner culture of the cell line MP1-44H was grown at 37°C for 5 days for antibody production. The culture supernatant was obtained free of cells by centrifugation and filtration through a 0.22 micron filter apparatus. The clarified supernatant was passed over a Protein A cartridge (Nygene, New York). Immunoglobulin was eluted using 0.1 M sodium citrate buffer pH 30. The pH of the eluting fractions containing the antibody was raised to neutrality by the addition of Tris base, pH 9.0. The antibody-containing fractions were concentrated and passed over a Pharmacia Superose 12 HR 10/30 gel filtration column. A protein was judged to be homogeneous by SDS polyacrylamide gel electrophoresis. Isoelectric focusing further demonstrated the purity of MP1-44H.

20 The biological performance of the human composite antibody, MP1-44H, was evaluated by comparing immunohistochemistry results with two other anti-TAG-72 antibodies CC49 (ATCC No. HB 9459) and Ch44 (ATCC No. HB 9884). Sections of human colorectal tumor embedded in paraffin were tested with the three antibodies by methods familiar to those skilled in this art. All three antibodies gave roughly equivalent binding recognition of the tumor antigen present on the tumor tissue sample.

30 A further test of the affinity and biological integrity of the human composite antibody MP1-44H was a competition assay, based on cross-competing radioiodine-labeled versions of the antibody with CC49 and Ch44 in all combinations. From the data shown in Figure 20, it

is apparent that the affinity of all 3 antibodies is equivalent and can bind effectively to tumor antigen.

MP1-44H (ATCC HB 10426) and MP1-84H (ATCC HB 10427) were deposited at the American Type Culture Collection (ATCC). The contract with ATCC provides for permanent availability of the cell lines to the public on the issuance of the U.S. patent describing and identifying the deposit or the publications or upon the laying open to the public of any U.S. or foreign patent application, which ever comes first, and for availability of the cell line to one determined by the U.S. Commissioner of Patents and Trademarks to be entitled thereto according to 35 CFR §122 and the Commissioner's rules pursuant thereto (including 37 CFR §1.14 with particular reference to 886 OG 638). The assignee of the present application has agreed that if the cell lines on deposit should die or be lost or destroyed when cultivated under suitable conditions for a period of thirty (30) years or five (5) years after the last request, it will be promptly replaced on notification with viable replacement cell lines.

Example 2

Single-chain antibodies consist of a V_L , V_H and a peptide linker joining the V_L and V_H domains to produce SCFVs. A single chain antibody, SCFV1, was constructed to have the Hum4 V_L as V Domain 1 and CC49 V_H as V Domain 2 (see Figure 21).

The polypeptide linker which joins the two V domains was encoded by the DNA introduced at the 3' end of the V_L DNA during the PCR. The oligonucleotides SCFV1a and SCFV2 were designed to obtain the DNA segment

incorporating part of the yeast invertase leader sequence, the Hum4 VL and the SCFV linker.

The polypeptide linker for SCFV1 was encoded in oligonucleotide SCFV1b (see below). The underlined portions of the oligonucleotides SCFV1a and SCFV1b are complementary to sequences in the Hum4 VL and linker respectively. The sequences of SCFV1a and SCFV1b are as follows, with the hybridizing sequences underlined:

10

SCFV1a with the *Hind* III in bold:

15

Hind III

5' CTGCAAGCTTCCTTTTCCTTTTGGCTGGTTTTGCAGCCAAAATATCTGCAG
ACATCGTGATGACCCAGTC-3'

20

SCFV1b with the *Aat* II site in bold:

5'-CGTAAGACGTCTAAGGAACGAAATTGGGCCAATTGTTCTGAGGA
GACCGAACCTGACTCCTTCACCTTGGTCCCTCCGCG-3'

25

The target DNA in the PCR was pRL1001 (shown in Figure 18). The PCR was performed pursuant to the teachings of Mullis *et al. supra*. A DNA fragment containing the Hum4 VL-linker DNA component for the construction of SCFV1 was obtained and purified by polyacrylamide gel electrophoresis according to the teachings of Sambrook *et al. supra*.

30

p49 g1-2.3, containing CC49 V_H, was the target DNA in the PCR. PCR was performed according to the methods of Mullis *et al.*, *supra*. The oligonucleotides used for the PCR of CC49 V_H are as follows, with the hybridizing sequences underlined:

5

SCFV1c, with the *Aat* II site in bold:

10

5'-CCTTAGACGTCCAGTTGCAGCAGTCTGACGC-3'

15

SCFV1d, with the *Hind* III site in bold:

20

5'-GATCAAGCTTCACTAGGAGACGGTGACTGAGGTTCC-3'

The purified Hum4 V_L-linker and V_H DNA fragments were treated with *Aat* II (New England Biolabs, Beverly, MA) according to the manufacturer's protocol, and purified from a 5 percent polyacrylamide gel after electrophoresis. An equimolar mixture of the *Aat* II fragments was ligated overnight. The T4 DNA ligase was heat inactivated by heating the ligation reaction mixture at 65 °C for 10 minutes. Sodium chloride was added to the mixture to give a final concentration of 50 mM and the mixture was further with *Hind* III. A *Hind* III DNA fragment was isolated and purified from a 4.5 percent polyacrylamide gel and cloned into a yeast expression vector (see Carter *et al.* (1987), In: DNA

Cloning, A Practical Approach, Glover (ed.) Vol. III: 141-161). The sequence of the fragment, containing the contiguous SCFV1 construct, is set forth in Figure 22.

5 The anti-TAG-72 SCFV1 described herein
utilized the yeast invertase leader sequence (shown as
positions -19 to -1 of Figure 22), the Hum4 VL (shown as
positions 1 to 113 of Figure 22), an 18 amino acid
linker (shown as positions 114 to 132 of Figure 22) and
10 CC49 VH (shown as positions 133 to 248 of Figure 22).

The complete DNA and amino acid sequence of
SCFV1 is given in Figure 22. The oligonucleotides used
to sequence the SCFV1 are set forth below.

15 TPI:

5'-CAATTTTTTGTGGTATTCTTTTC-3'.

HUVKF3:

20 5'-CCTGACCGATTTCAGTGGCAG-3'.

DC113:

5'-TCCAATCCATTCCAGGCCCTGTTTCAGG-3'.

25

SUC2T:

5'-CTTGAACAAAGTGATAAGTC-3'.

30

Example 3

A plasmid, pCGS517 (Figure 23), containing
a prorennin gene was digested with *Hind* III and a 6.5 kb
fragment was isolated. The plasmid pCGS517 has a
triosephosphate isomerase promoter, invertase [SUC2]
signal sequence, the prorennin gene and a [SUC2]

terminator. The *Hind* III-digested SCFV1 insert obtained above (see Figure 23) was ligated overnight with the *Hind* III fragment of pCGS517 using T4 DNA ligase (Stratagene, La Jolla, CA).

5 The correct orientation existed when the
Hind III site of the insert containing part of the
invertase signal sequence ligated to the vector DNA to
form a gene with a contiguous signal sequence. *E. coli*
10 DHI (Invitrogen) cells were transformed and colonies
screened using a filter-microwave technique (see
Zuluwela, *et al.* (1989), Nucleic Acids Research, 17:452).
From a transformation plate having several hundred
colonies, 3 positive clones were obtained. Digesting
15 the candidate plasmids with *Sal* I and *Kpn* I, each a
single cutter, differentiated between orientations by
the size of the DNA fragments produced. A single clone,
pDYSCFV1 (Figure 23), had the correct orientation and
was used for further experimentation and cloning. The
20 probe used was derived from pRL1001, which had been
digested with *Kpn* I and *Cla* I (see Figure 18). The
probe DNA was labeled with ³²P α-dCTP using a random
oligonucleotide primer labeling kit (Pharmacia LKB
25 Biotechnology, Piscataway, NJ).

 The next step was to introduce the *Bgl* II-
Sal I fragment from pDYSCFV1 into the same restriction
sites of another vector (ca. 9 kb), which was derived
30 from PCGS515 (Figure 23). to give an autonomously
replicating plasmid in *S. cerevisiae*.

 DNA from the vector and insert were
digested in separate reactions with *Bgl* II and *Sal* I
using 10X buffer number 3 (50 mM Tris-HCl (pH 8.0), 100
mM NaCl, BRL). The DNA fragment from pDYSCFV1 was run

in and electroeluted from a 5 percent polyacrylamide gel and the insert DNA was run and electroeluted from a 3.75 percent polyacrylamide gel. A standard ligation using T4 DNA ligase (Stratagene) and a transformation using *E. coli* DH1 (Invitrogen) was carried out. Out of 6 clones selected for screening with *Bgl* II and *Sal* II, all 6 were correctly oriented, and one was designated pCGS515/SCFV1 (Figure 23).

DNA sequencing of pCGS515/SCFVI DNA was done using a Sequenase™ kit (U.S. Biochemical, Cleveland, OH) using pCGS515/SCFV1 DNA. The results have been presented in Figure 22 and confirm the sequence expected, based on the linker, the Hum4 V_L and the CC49 V_H.

Transformation of yeast cells using the autonomously replicating plasmid pCGS515/SCFV1 was carried out using the lithium acetate procedures described in Ito *et al.* (1983), J. Bacteriol., 153:163-168; and Treco (1987), In: Current Protocols in Molecular Biology, Ausebel *et al.* (eds), 2:13.71-13.7.6. The recipient strain of *S. cerevisiae* was CGY1284 having the genotype - MAT a (mating strain a), ura 3-52 (uracil auxotrophy), SSC1-1 (supersecreting 1), and PEP4⁺ (peptidase 4 positive).

Transformed clones of CGY1284 carrying SCFV plasmids were selected by their ability to grow on minimal media in the absence of uracil. Transformed colonies appeared within 3 to 5 days. The colonies were transferred, grown and plated in YEPD medium. Shake flasks were used to provide culture supernatant with expressed product.

An ELISA procedure was used to detect biological activity of the SCFV1. The assay was set up such that the SCFV would compete with biotinylated CC49 (biotin-CC49) for binding to the TAG-72 antigen on the ELISA plate .

5

SCFV1 protein was partially purified from a crude yeast culture supernatant, using a Superose 12 gel filtration column (Pharmacia LKB Biotechnology), and found to compete with biotinylated CC49 in the competition ELISA. These results demonstrate that the SCFV1 had TAG-72 binding activity.

10

The SCFV1 protein has been detected by a standard Western protocol (see Towbin *et al.* (1979), Proc. Natl. Acad. Sci. U.S.A., 76:4350-4354). The detecting agent was biotinylated FAID14 (ATCC No. CRL 10256), an anti-idiotypic monoclonal antibody prepared from mice that had been immunized with CC49. A band was visualized that had an apparent molecular weight of approximately 26,000 daltons, the expected size of the SCFV1. This result demonstrated that the SCFV1 had been secreted and properly processed.

15

20

25 Example 4

The following example demonstrates the cloning of human VH genes into a SCFV plasmid construct containing sequence coding for the Hum4 VL and a 25 amino acid linker called UNIHOPe.

30

A vector was prepared from plasmid pRW 83 containing a chloramphenicol resistance (Cam^r) gene for clone selection, and a *penP* gene with a *penP* promoter and terminator (see Mezes, *et al.* (1983), J. Biol. Chem., 258:11211-11218) and the *pel B* signal sequence (see Lei

etal. (1987) *supra*). The vector was designated Fragment A. (see Figure 24). The *penP* gene was removed with a *Hind* III/*Sal* I digest.

5 The *penP* promoter and *pel B* signal sequence were obtained by a PCR using pRW 83 as a template and oligonucleotides *penP1* and *penP2* as primers. The fragment was designated Fragment B (see Figure 24). A *Nco* I enzyme restriction site was introduced at the 3' end of the signal sequence region by the *penP2* oligonucleotide.

penP1:

5'-CGATAAGCTTGAATTCCATCACTTCC-3'

15 *penP2*:

5'-GGCCATGGCTGGTTGGGCAGCGAGTAATAACAATCCAGCG GCT
GCCGTAGGCAATAGGTATTTTCATCAAAATCGTCTCCCTCCGTTTGAA-3'

20 A SCFV comprised of a Hum4 V_L, a CC49 V_H, and an 18 amino acid linker (Lys Glu Ser Gly Ser Val Ser Ser Glu Gln Leu Ala Gln Phe Arg Ser Leu Asp) was obtained from pCGS515/SCFV1 by PCR using oligonucleotides *penP3* and *penP6*. This fragment was designated Fragment D (see Figure 24). A *Bcl* I site was introduced at the 3' end
25 of the V_H region by the *penP6* oligonucleotide.

penP3:

5'-GCTGCCCAACCAGCCATGGCCGACATCGTGATGACCCAGTCTCC-3'

30 *penP6*(-):

5'-CTCTTGATCACCAAGTGACTTTATGTAAGATGATGTTTTG ACG
GATTCATCGCAATGTTTTTATTTGCCGGAGACGGTGACTGAGGTTCC-3'

Fragments B and D were joined by PCR using oligonucleotides *penP1* and *penP6*, following the

procedures of Horton *et al.*, *supra*. The new fragment was designated E (See Figure 24).

5 Fragment C containing the *penP* termination codon was isolated by digesting pRW 83 with *Bcl* I and *Sal* I, and designated Fragment C. pRW 83 was isolated from *E. coli* strain GM161, which is DNA methylase minus or *dam*⁻.

Plasmid pSCFV 31 (see Figure 24) was created with a three part ligation Fragments A, C, and E.

10 The *Nco* I restriction enzyme site within the *Cam*^r gene and the *Hind* III site located at the 5' end of the *penP* promoter in pSCFV 31 were destroyed through a PCR DNA amplification using oligonucleotides *Nco*1.1 and *Nco*1.3(-) to generate an *Eco* RI-*Nco* I fragment and
 15 oligonucleotides *Nco*1.2 and *Nco*1.4c(-) to generate a *Nco* I to *Eco* RI fragment. These two fragments were joined by PCR-SOE using oligonucleotides *Nco*1.1 and *Nco*1.4c(-). The oligonucleotides are set forth below:

20 *Nco*1.1:

5'-TCCGGAATTCCGTATGGCAATGA-3'

*Nco*1.3(-):

5'-CTTGCGTATAATATTTGCCCATCGTGAAAACGGGGGC-3'

25 *Nco*1.2:

5'-ATGGGCAAATATTATACGCAAG-3'

*Nco*1.4c(-):

30

5'-CACTGAATTCATCGATGATAAGCTGTCAAACATGAG-3'

pSCFV 31 was digested with *Eco* RI and the larger fragment was isolated by polyacrylamide gel electrophoresis. To prevent self ligation, the DNA was

dephosphorylated using calf intertinal alkaline phosphatase according to the teachings of Sambrook *et al.*, *supra*.

5 A two part ligation of the larger pSCFV 31 digested fragment and the PCR-SOE fragment, described above, resulted in the creation of pSCFV 31b (see Figure 25).

10 pSCFV 31b was digested with *Nco* I and *Sal* I and a fragment containing the *Cam^r* gene was isolated.

The Hum4 *V_L* was obtained by PCR DNA amplification using pCGS515/SCFV1 as a template and oligonucleotides 104BH1 and 104BH2(-) as primers.

15 104BH1:

5'-CAGCCATGGCCGACATCGTGATGACCCAGTCTCCA-3'

104BH2(-):

20 5'-AAGCTTGCCCCATGCTGCTTTAACGTTAGTTTTATCTGCTGG
AGACAGAGTGCTTCTGCCTCCACCTTGGTCCCTCCGCCGAAAG-3'

25 The CC49 *V_H* was obtained by PCR using p49 g1-2.3 (Figure 5) as a template and oligonucleotides 104B3 and 104B4(-) as primers. A *Nhe* I enzyme restriction site was introduced just past the termination codon in the 3' end (before the *Bcl* I site) by oligonucleotide 104B4(-).

30 104B3:

5'-GTAAAGCAGCATGGGGCAAGCTTATGACTCAGTTGCAGCAGTCTGACGC-3'

104B4(-):

5'-CTCTTGATCACCAAGTGACTTTATGTAAGATGATGTTTTGACGGATT
CATCGCTAGCTTTTTATTTGCCATAATAAGGGGAGACGGTGACTGAGGTTCC-3'

5 In the PCR which joined these two fragments using oligonucleotides 104BH1 and 104B4(-) as primers, a coding region for a 22 amino acid linker was formed.

10 A fragment C (same as above) containing the *penP* termination codon was isolated from pRW 83 digested with *Bcl* I and *Sal* I.

15 Plasmid pSCFV 33H (see figure 25) was created with a three part ligation of the vector, fragment C, and the SCFV fragment described above.

pSCFV 33H was digested with *Nco*I and *Nhe*I, and the DNA fragment containing the *Cam^r* gene was isolated as a vector.

20 Hum4 VL was obtained by PCR DNA amplification using pRL1001 (see Figure 18) as a template and oligonucleotides UNIH1 and UNIH2(-) as primers. Oligonucleotides for the PCR were:

25 UNIH1:

5'-CAGCCATGGCCGACATTGTGATGTCACAGTCTCC-3'

30 The *Nco* I site is in bold and the hybridizing sequence is underlined.

UNIH2(-):

5'-GAGGTCCGTAAGATCTGCCTCGCTACCTAGCAAA
AGGTCCTCAAGCTTGATCACCACCTTGGTCCCTCCGC-3'

The *Hind* III site is in bold.

The CC49 V_H was obtained by a PCR using p49 g1-2.3 (see Figure 6) as a template and oligonucleotides UNI3 and UNI4(-) as primers.

UNI3:

5 5'-AGCGAGGCAGATCTTACGGACCTCGAGGTT**CAGTTGCAGCAGTCTGAC**-3'.

The *Xho* I site is in bold and the hybridizing sequence is underlined.

UNI4(-):

10 5'-CATCGCTAGCTTTT**TATGAGGAGACGGT**ACTGAGGTTCC-3'.

The *Nhe* I site is in bold and the hybridizing sequence is underlined.

15 Oligonucleotides UNIH1 and UNI4(-) were used in the PCR-SOE amplification which joined the Hum4 V_L and CC49 V_H fragments and formed a coding region for a negatively charged fifteen amino acid linker. The DNA was digested with *Nhe* I and *Nco* I and ligated with the
20 vector fragment from the *Nco* I-*Nhe* I digest of pSCFV 33H. The resultant plasmid was designated pSCFV UNIH (shown in Figure 25).

25 With the construction of pSCFV UNIH, a universal vector for any SCFV was created with all the desired restriction enzyme sites in place.

pSCFV UNIH was digested with *Hind* III/*Xho* I, and the large DNA fragment containing the *Cam^r* gene. Hum4 V_L and CC49 V_H was isolated.

30 A fragment coding for a 25 amino acid linker, was made by annealing the two oligonucleotides shown below. The linker UNIH_{HOPE} is based on 205C SCA™ linker (see Whitlow, (1990) Antibody Engineering: New Technology and Application Implications. IBC USA

Conferences Inc, MA), but the first amino acid was changed from serine to leucine and the twenty-fifth amino acid were was changed from glycine to leucine, to accomodate the *Hind* III and *Xho* I restriction sites. The nucleotide sequence encoding the linker UNIHOPPE is set forth below:

UNIHOPPE (Figure 26):

5'-TATAAAGCTTAGTGCGGACGATGCGAAAAAGGATGCTGCGAAG
AAGGATGACGCTAAGAAAGACGATGCTAAAAAGGACCTCGAGTCTA-3'

UNIHOPPE(-) (Figure 26):

5'TAGACTCGAGGTCCTTTTTAGCATCGTCTTTCTTAGCGT CAT
CCTTCTTCGCAGCATCCTTTTTTCGCATCGTCCGCACTAAGCTTTATA-3'

The resulting strand was digested with *Hind* III/*Xho* I and ligated into the vector, thus generating the plasmid pSCFV UHH (shown in Figure 27). Plasmid pSCFV UHH expresses a biologically active, TAG-72 binding SCFV consisting of the Hum4 VL and CC49 VH. The expression plasmid utilizes the β -lactamase *penP* promoter, pectate lyase *pelB* signal sequence and the *penP* terminator region. Different immunoglobulin light chain variable regions can be inserted in the *Nco* I-*Hind* III restriction sites, different SCFV linkers can be inserted in the *Hind* III-*Xho* I sites and different immunoglobulin heavy chain variable regions can be inserted in the *Xho* I-*Nhe* I sites.

E. coli AG1 (Stratagene) was transformed with the ligation mix, and after screening, a single chloramphenicol resistant clone, having DNA with the correct restriction map, was used for further work.

The DNA sequence and deduced amino acid sequence of the SCFV gene in the resulting plasmid are shown in Figure 26.

E. coli AG1 containing pSCFV UHH were grown in 2 ml of LB broth with 20 µg/mL chloramphenicol (CAM 20). The culture was sonicated and assayed using a competition ELISA. The cells were found to produce anti-TAG-72 binding material. The competition assay was set up as follows: a 96 well plate was derivatized with a TAG-72 preparation from LS174T cells. The plate was blocked with 1% BSA in PBS for 1 hour at 31 °C and then washed 3 times with 200 µL of biotinylated CC49 (1/20,000 dilution of a 1 mg/mL solution) were added to the wells and the plate was incubated for 30 minutes at 31 °C. The relative amounts of TAG-72 bound to the plate, biotinylated CC49, streptavidin-alkaline phosphatase, and color development times were determined empirically in order not to have excess of either antigen or biotinylated CC49, yet have enough signal to detect competition by SCFV. Positive controls were CC49 at 5 µg/mL and CC49 Fab at 10 µL/mL. Negative controls were 1% BSA in PBS and/or concentrated LB. Unbound proteins were washed away.

Fifty microliters of a 1:1000 dilution of streptavidin conjugated with alkaline phosphatase (Southern Biotechnology Associates, Inc., Birmingham, AL) were added and the plate was incubated for 30 minutes at 31 °C. The plate was washed 3 more times. Fifty microliters of a para-nitrophenylphosphate solution (Kirkegaard & Perry Laboratories, Inc., Gaithersburg, MD) were added and the color reaction was allowed to develop for a minimum of 20 minutes. The relative amount of SCFV binding was measured by optical density scanning at 405-450 nm using a microplate reader (Molecular Devices Corporation, Menlo Park, CA). Binding of the SCFV resulted in decreased binding of the

biotinylated CC49 with a concomitant decrease in color development. The average value for triplicate test samples is shown in the table below:

<u>Sample (50 μL)</u> <u>(mixed 1:1 with CC49 Biotin)</u>	<u>OD 405 nm - OD 450 nm Value</u> <u>at 50 minutes</u>
Sonicate <i>E. coli</i> AG1/ pSCFVUHH clone 10	0.072
Sonicate <i>E. coli</i> AG1/ pSCFVUHH clone 11	0.085
CC49 at 5 mg/mL	0.076
CC49 Fab at 10 mg/mL	0.078
LB (negative control)	0.359

20 The data indicates that there was anti-TAG-72 activity present in the *E. coli* AGI/pSCFVUHH clone sonicate.

Example 7

25 The plasmid pSCFVUHH may be used to host other V_H genes on *Xho* I-*Nhe* I fragments and test in a SCFV format, following the procedures set forth below. A schematic for this process is shown here.

30

Discovery of Hum4 V_L-V_H combinations that compete with known prototype TAG-binding antibodies or mimetics.

pSCFVUHH *Xho* I/*Nhe* I
Vector DNA Fragment
(CC49 V_H removed)
or pATDFLAG *Xho*I/*Nhe*I Vector DNA Fragment

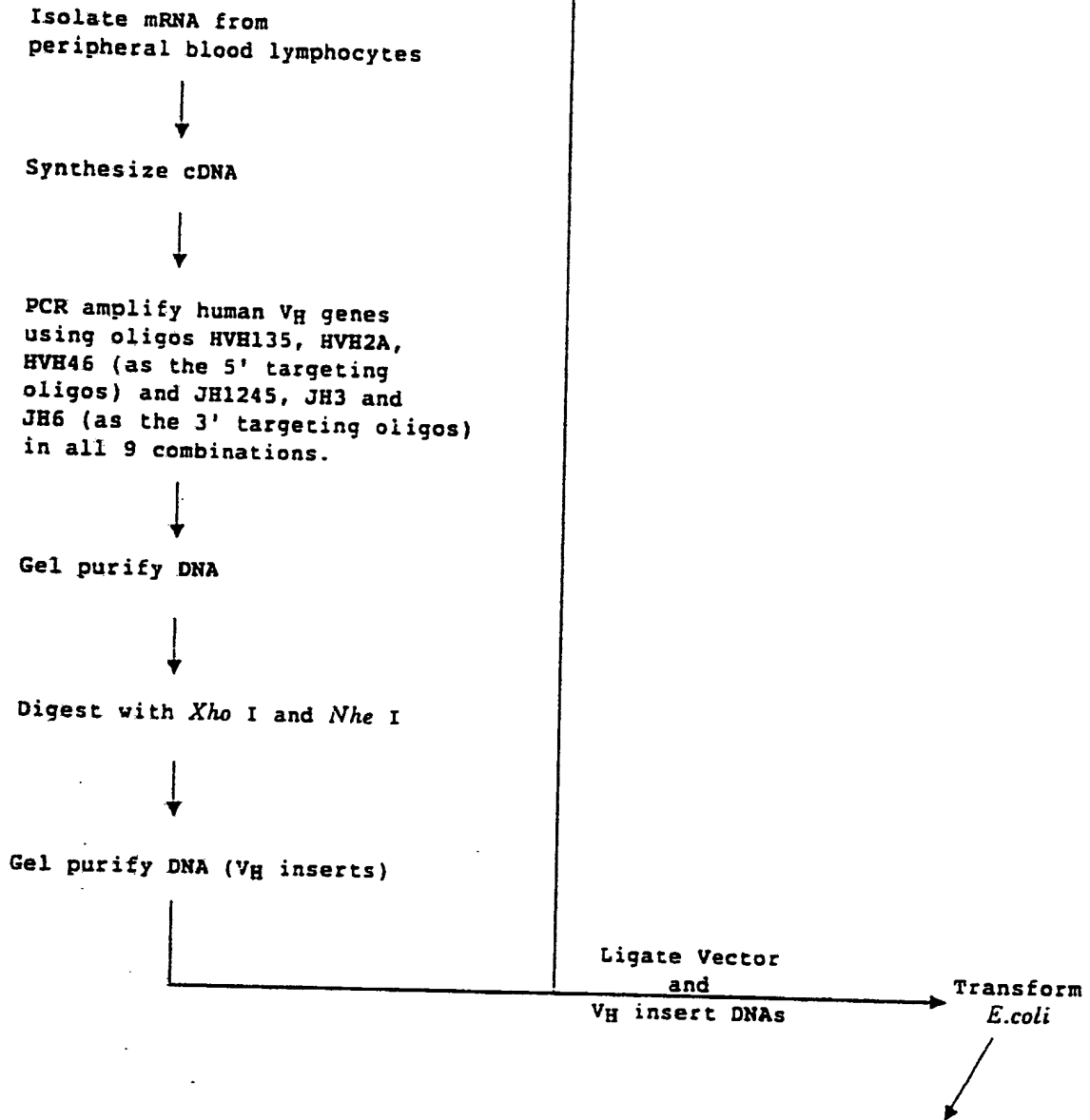

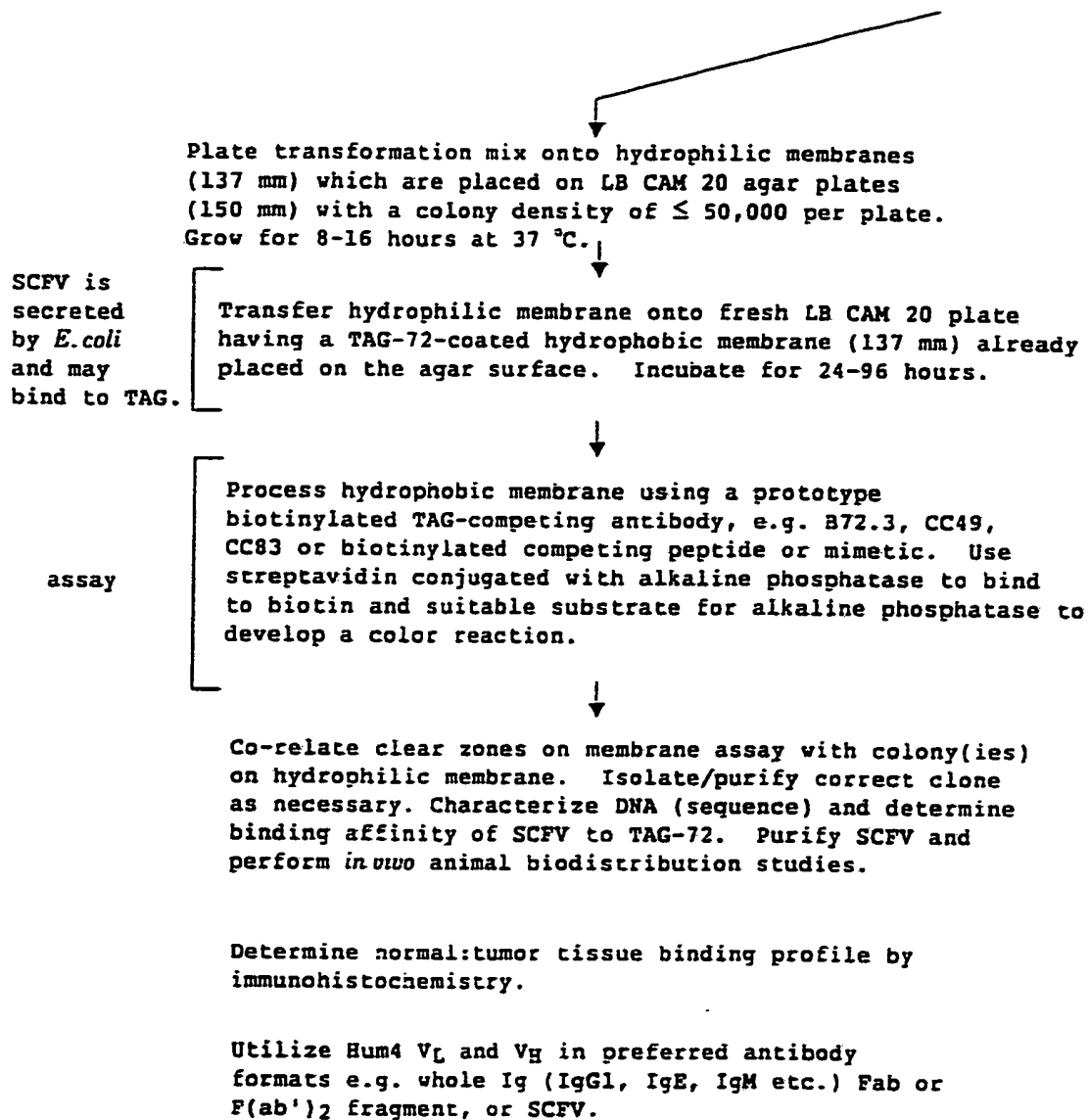

Isolating total RNA from peripheral blood lymphocytes:

Blood from a normal, healthy donor is drawn into three 5 mL purple-cap Vacutainer tubes. Seven mL of blood are added to two 15 mL polypropylene tubes. An equal volume of lymphoprep (cat# AN5501, Accurate) is added and the solution is mixed by inversion. Both tubes are centrifuged at 1000 rpm and 18 °C for 20 minutes. The resulting white area near the top of the liquid (area not containing red blood cells) is removed from each sample and placed into two sterile polypropylene centrifuge tube. Ten mL of sterile PBS are added and the tube mixed by inversion. The samples are centrifuged at 1500 rpm and 18 °C for 20 minutes. Total RNA is isolated from resulting pellet according to the RNazol B Method (Chomczynski and Sacchi (1987), Analytical Biochemistry, 162:156-159). Briefly, the cell pellets are lysed in 0.4 mL RNazol solution (cat#:CS-105, Cinna/Biotechx). RNA is solubilized by passing the cell pellet through a 1 mL pipet tip. Sixty µL of chloroform are added and the solution is shaken for 15 seconds. RNA solutions are then placed on ice for 5 minutes. Phases are separated by centrifugation at 12000 x g and 4 °C for 15 minutes. The upper (aqueous) phases are transferred to fresh RNase-free microcentrifuge tubes. One volume of isopropanol is added and the samples placed at -20 °C for 1 hour. The samples are then placed on dry ice for 5 minutes and finally centrifuged for 40 seconds at 14,000 x g and 4 °C. The resulting supernatant is removed from each sample and the pellet is dissolved in 144 µL of sterile RNase-free water. Final molarity is brought to 0.2M NaCL. The DNA is reprecipitated by adding 2 volumes of 100% ethanol, leaving on dry ice for 10 minutes, and

centrifugation at 14,000 rpm and 4 °C for 15 minutes. The supernatants are then removed, the pellets washed with 75% ethanol and centrifuged for 8 minutes at 12000 x g and 4 °C. The ethanol is then removed and the pellets dried under vacuum. The resulting RNA is then dissolved in 20 sterile water containing 1 µl RNasin (cat#:N2511, Promega).

cDNA synthesis:

cDNA synthesis is performed using a Gene Amp™ PCR kit (cat#: N808-0017 Perkin Elmer Cetus), RNasin™ (cat#: N2511, Promega), and AMV reverse transcriptase (cat#: M9004, Promega). The following protocol is used for each sample:

	<u>Components</u>	<u>Amount</u>
	MgCl ₂ solution	4 µl
	10 µl PCR buffer II	2 µl
	dATP	2 µl
	dCTP	2 µl
	dGTP	2 µl
	dTTP	2 µl
	3' primer (random hexamers)	1 µl
	RNA sample	2 µl
	RNasin	1 µl
	AMV RT	1.5 µl

Samples are heated at 80 °C for 3 minutes then slowly cooled to 48 °C. The samples are then centrifuged for 10 seconds. AMV reverse transcriptase is added to the samples which are then incubated for 30 minutes at 37 °C. After incubation, 0.5 µl of each dNTP

and 0.75 reverse transcriptase (cat#:109118, Boehringer Mannheim) are added. The samples are incubated for an additional 15 minutes at 37 °C.

PCR Reaction:

5 Oligonucleotides are designed to amplify human VH genes by polymerase chain reaction. The 5' oligonucleotides are set forth below:

HVH 135:

10 5'-TATTCTCGAGGTGCA(AG)CTG(CG)TG(CG)AGTCTGG-3'

HVH2A:

5'-TATTCTCGAGGTCAA(CG)TT(AG)A(AG)GGAGTCTGG-3'

HVH46:

15 5'-TATTCTCGAGGTACAGCT(AG)CAG(CG)(AT)GTC(ACG)GG-3'

The 3' oligonucleotides are set forth below:

JH1245:

5'-TTATGCTAGCTGAGGAGAC(AG)GTGACCAGGG-3'

20 JH3:

5'-TTATGCTAGCTGAAGAGACGGTGACCATTG

JH6:

5'-TTATGCTAGCTGAGGAGACGGTGACCCTGG-3'

25 PCR reactions are performed with a GeneAmp™ PCR kit (cat#:N808-0017, Perkin Elmer Cetus). Components are listed below:

30

	<u>Components</u>	<u>Amount</u>
	ddH ₂ O	75 µl
	10 x buffer	10 µl
5	dATP	2 µl
	dCTP	2 µl
	dGTP	2 µl
	dTTP	2 µl
10	1* Target DNA	1 µl
	2* 5' primer	2.5 µl
	3' primer	2.0 µl
	3* AmpliTaq™ Polymerase	1.3 µl

15 *components added in order at 92 °C
of first cycle

PCR program:

step 1	94 °C for 30 seconds
step 2	60 °C for 1 minutes
step 3	72 °C for 45 seconds

20 Approximately 35 cycles are completed for each reaction.
All PCR reactions are performed using a Perkin Elmer
Cetus PCR System 9600 thermal cycler.

25

Treatment of Human V_H inserts with Xho I and Nhe I:

30 Human V_H genes are digested with Xho I (cat#: 131L, New England Biolabs) and Nhe I (cat#: 146L, New England Biolabs). The following protocol is used for each sample:

	<u>SUBSTANCE</u>	<u>AMOUNT</u>
	DNA	20 μ l
	NEB Buffer #2	4.5 μ l
5	<i>Nhe</i> I	2 μ l
	<i>Xho</i> I	2 μ l
	ddH ₂ O	16.5 μ l

10 Samples are incubated at 37 °C for one hour.
After this incubation, an additional 1.5 μ L *Nhe* I is
added and samples are incubated an additional two hours
at 37 °C.

15 Purification of DNA:

 After the restrictive enzyme digest, DNA is run
on a 5 percent polyacrylamide gel (Sambrook *et al.* (1989),
supra). Bands of 390-420 bp in size are excised from
the gel. DNA is electroeluted and ethanol precipitated
20 according to standard procedures.

 PCR products resulting from oligonucleotide
combinations are pooled together: JH1245 with HVH135,
HVH2A and HVH46; JH3 with HVH135, HVH2A and HVH46; JH6
25 with HVH135, HVH2A and HVH46. The volume of the
resulting pools are reduced under vacuum to 50
microliters. The pools are then purified from a 4
percent polyacrylamide gel (Sambrook *et al.* (1989), *supra*)
to isolate DNA fragments. Bands resulting at 390-420 bp
30 are excised from the gel. The DNA from excised gel
slices is electroeluted according to standard protocols
set forth in Sambrook, *supra*.

Isolation of pSCFVUHH *Xho* I/*Nhe* I Vector Fragment

Approximately 5 µg in 15 µL of pSCFVUHH plasmid is isolated using the Magic Mini-prep™ system (Promega). To this is added 5.4 µL OF 10X Buffer #2 (New England Biolabs), 45 units of *Xho* I (New England Biolabs), 15 units of *Nhe* I and 24 µL of ddH₂O. The reaction is allowed to proceed for 1 hour at 37 °C. The sample is loaded on a 4% polyacrylamide gel, electrophoresed and purified by electroelution, as described earlier. The DNA pellet is dissolved in 20 µL of ddH₂O.

One hundred nanograms of pSCFVUHH digested with *Xho* I/*Nhe* I is ligated with a 1:1 molar ratio of purified human V_H inserts digested with *Xho* I and *Nhe* I using T4 DNA ligase (Stratagene). Aliquots are used to transform competent *E. coli* AG1 cells (Stratagene) according to the supplier's instructions.

GVWP hydrophilic membranes (cat# GVWP14250, Millipore) are placed on CAM 20 LB agar plates (Sambrook *et al.*, 1989). One membrane is added to each plate. Four hundred microliters of the *E. coli* AG1 transformation suspension from above are evenly spread over the surface of each membrane. The plates are incubated for 16 hours at 37 °C ambient temperatures.

Preparation of TAG-72-coated membranes:

A 1% dilution of partially purified tumor associated glycoprotein-72 (TAG-72) produced in LS174 T-cells is prepared in TBS (cat# 28376, Pierce). Ten milliliters of the TAG dilution are placed in a petri plate (cat# 8-757-14, Fisher) for future use. Immobilon-P PVDF transfer membranes (cat# SE151103, Millipore) are immersed in methanol. The membranes are

than rinsed three times in sterile double distilled water. After the final wash, the excess water is allowed to drain. Each of the membranes are placed in 10 milliliters of dilute TAG-72. The membranes are incubated at ambient temperature from 1 hour with gentle shaking. After incubation, the membranes are blocked with Western blocking solution (25 mM Tris, 0.15 M NaCl, pH 7.6; 1% BSA) for about 1 hour at ambient temperature.

Blocking solution is drained from the TAG membranes. With the side exposed to TAG-72 facing up, the membranes are placed onto fresh CAM 20 plates. Resulting air pockets are removed. The bacterial membranes are then added, colony side up, to a TAG membrane. The agar plates are incubated for 24 to 96 hours at ambient temperatures.

The orientation of the TAG-72 and bacterial membranes are marked with permanent ink. Both membranes are removed from the agar surface. The TAG-72 membrane is placed in 20 ml of Western antibody buffer (TBS in 0.05% Tween-20, cat# P-1379, Sigma Chemical Co.; 1% BSA, cat#3203, Biocell Laboratories) containing 0.2 ng of CC49-Biotin probe antibody. The bacterial membranes are replaced on the agar surface in their original orientation and set aside. CC49-Biotin is allowed to bind to the TAG membranes for 1 hour at 31 °C with gentle shaking. The membranes are then washed three times with TTBS (TBS, 0.05% Tween-20) for 5 minutes on an orbital shaker at 300 rpm. Streptavidin alkaline phosphatase (cat# 7100-04, Southern Biotechnology Associates) is added to Western antibody buffer to produce a 0.1% solution. The TAG-72 membranes are each immersed in 16 milliliters of the streptavidin solution and allowed to incubate for 30 minutes at 31 °C with

gentle shaking. After incubation, the membranes are washed as previously described. A final wash is then performed using Western alkaline phosphate buffer (8.4 g NaCO₃, 0.203 g MgCl₂-H₂O, pH 9.8), for 2 minutes at 200 rpm at ambient temperature. To develop the membranes, Western blue stabilized substrate (cat# S384B, Promega) is added to each membrane surface. After 30 minutes at ambient temperatures, development of the membranes is stopped by rinsing the membranes three times with ddH₂O. The membranes are then photographed. The membranes are then photographed and clear zones are correlated with colonies on the hydrophilic membrane, set aside earlier. Colony(ies) are isolated for growth in culture and used to prepare plasmid DNA for sequencing and protein preparation to evaluate specificity and affinity.

Identification of Hum4 V_L, human V_H combinations using pATDFLAG.

In a second assay system, Hum4 V_L - human V_H combinations are discovered that bind to TAG-72 according to the schematic, *supra*, except for the following: at the assay step, IBI MII antibody is used as a probe to detect any Hum4 V_L - V_H SCFV combinations that have bound to the hydrophobic membrane coated with TAG-72.

The plasmid pATDFLAG was generated from pSCFVUHH (see Figure 29) to incorporate a flag-coating sequence 3' of any human V_H genes to be expressed contiguously with Hum4 V_L. The plasmid pATDFLAG, when digested with *Xho* I and *Nhe* I and purified becomes the human C_H discovery plasmid containing Hum4 V_L in this SCFV format. The plasmid pATDFLAG was generated as follows. Plasmid pSCFVUHH treated with *Xho* I and *Nhe* I (isolated and described above) was used in a ligation

reaction with the annealed FLAG and FLAGNC oligonucleotides.

FLAGC:

5'-TCGAGACAATGTCGCTAGCGACTACAAGGACGATGATGACAAATAAAAAC-3'

5

FLAGNC:

5'-CTAGGTTTTTATTTGTCATCATCGTCCTTGTAGTCGCTAGCGACATTGTC-3'

10

Equimolar amounts (1×10^{-10} moles of each of the oligonucleotides FLAGC and FLAGNC were mixed together using a ligation buffer (Stratagene). The sample is heated to 94 °C and is allowed to cool to below 35 °C before use in the ligation reaction below.

15

Ligation Reaction to Obtain pATDFLAG

20

25

<u>COMPONENT</u>	<u>AMOUNT</u>
pSCFVUHH <i>Xho</i> I/ <i>Nhe</i> I vector	1.5 μ l
ANNEALED FLAGC/FLAGNC	0.85 μ l
10X Ligation buffer	2 μ l
T4 DNA LIGASE	1 μ l
10 MM ATP	2 μ l
ddH ₂ O	12.65 μ l

30

The reaction is carried out using the following components and amounts according the ligation protocol disclosed above. *E coli* AG1 cells (Stratagene) are transformed with 3 μ l of the above ligation reaction and colonies selected using CAM 20 plates. Clones having

appropriate *Nhe* I, *Xho* I and *Nhe* I/*Xho* I restriction patterns are selected for DNA sequencing.

The oligonucleotide used to verify the sequence of the FLAG linker in PATDFLAG (see Figure 28) is called
5 PENPTSEQ: 5'-CTTTATGTAAGATGATGTTTTG-3. This oligonucleotide is derived from the non-coding strand of the *penP* terminator region. DNA sequencing is performed using Sequenase™ sequencing kit (U.S. Biochemical, Cleveland, OH) following the manufacturer's directions.
10 The DNA and deduced amino acid sequences of the Hum4 V_L - UNIHOPE linker - FLAG peptide is shown in Figure 28.

Generating pSC49FLAG

15 The CC49V_H is inserted into the sites of *Xho* I - *Nhe* I pATDFLAG (see Figure 29) and evaluated for biological activity with the purpose of serving as a positive control for the FLAG assay system to detect
20 binding to TAG-72. The new plasmid, called pSC49FLAG (see Figure 29) is generated as follows. The plasmid pATDFLAG (5 mg, purified from a 2.5 ml culture by the Magic Miniprep™ system (Promega) is treated with *Xho* I and *Nhe* I and the large vector fragment purified as
25 described above for pSCFVUHH. The CC49 V_H insert DNA fragment is obtained by PCR amplification from pSCFVUHH and oligonucleotides UNI3 as the 5' end oligonucleotide and SC49FLAG as the 3' end oligonucleotide. The resulting DNA and amino acid sequences of this SCFV
30 antibody, with the FLAG peptide at the C-terminus, is shown in Figure 30. The PCR reaction is carried out using 100 pmol each of the oligonucleotides, 0.1 ng of pSCFVUHH target DNA (uncut) and the standard protocol and reagents provided by Perkin Elmer Cetus. The DNA is first gel purified, then treated with *Xho* I and *Nhe* I to

generate sticky ends and purified from a 4% polyacrylamide gel and electroeluted as described earlier. The DNA vector (pATDFLAG treated with *Xho* I and *Nhe* I) and the insert (CC49 V_H PCR product from pSCFVUHH treated with *Xho* I and *Nhe* I) are ligated in a 1:1 molar ratio, using 100 ng vector DNA (Stratagene kit) and used to transform *E. coli* AG1 competent cells (Stratagene) according to the manufacturer's directions. A colony with the correct plasmid DNA is picked as the pSC49FLAG clone.

Ligation of pATDFLAG Vector with PCR Amplified Hum4 V_H Inserts

The protocol for the ligation reaction is as follows:

	<u>COMPONENT</u>	<u>AMOUNT</u>
20	DNA vector:pATDFLAG <i>Xho</i> I/ <i>Nhe</i> I	2.5 µL
	Hum V _H (X) DNA inserts: <i>Xho</i> I/ <i>Nhe</i> I	6 µL
	10 mM ATP (Stratagene)	2 µL
	10X buffer (Stratagene)	2 µL
25	T4 DNA ligase (Stratagene)	1 µL
	ddH ₂ O	6.5 µL

DNA vector, ATP, 10X buffer and ddH₂O are combined. DNA insert and T4 DNA ligase are then added. Ligation reactions are then placed in a 4 L beaker containing H₂O at 18 °C. The temperature of the water

is gradually reduced by refrigeration at 4 °C overnight. This ligation reaction generates pHum4 V_L - hum V_H (X).

Transformation of *E. coli* AG1 with pHum4 V_L-Hum V_H (X)
Ligation Mix

5

Transformation of pATDFLAG into competent *E. coli* AG1 cells (Stratagene, La Jolla) is achieved following the supplier's protocol.

10

IBI MII Anti-FLAG Antibody Plate Assay

15

The first three steps, preparation of TAG-coated membranes, plating of bacterial membranes, and assembly of TAG and bacterial membranes, are the same as those described in the CC49-Biotin Competition Plate Assay.

20

After the 24 hour incubation at ambient temperatures, the membranes are washed with TTBS three times at 250 rpm for four minutes. The MII antibody (cat# IB13010, International Biotechnologies, Inc.) is then diluted with TBS to a concentration ranging from 10.85 µg/ml to 0.03 µg/ml. Ten milliliters of the diluted antibody are added to each membrane. The membranes are then incubated for 1 hour at ambient temperatures and shaken on a rotary shaker at 70 rpm. After incubation, the MII antibody is removed and the membranes are washed three times at 250 rpm and ambient temperatures for 5 minutes. The final wash is removed and 20 milliliters of a 1:2000 dilution of sheep anti-mouse horseradish peroxidase linked whole antibody (cat# NA931, Amersham) is prepared with TBS and added to each membrane. The membranes are again incubated for 1 hour at ambient temperatures and 70 rpm. Following incubation, the membranes are washed three times at 250

30

rpm and ambient temperature for 5 minutes each. Enzygraphic Webs (cat# IB8217051, International Biotechnologies, Inc.) are used according to develop the membranes, according to the manufacturer's instructions. The membranes are then photographed.

5

Instead of seeing a clear zone on the developed membrane for a positive Hum4 V_L-V_H (X) clone producing an SCFV that binds to TAG-72, (as seen with the competition screening assay) in this direct FLAG - detecting assay, a blue-purple spot is indicative of a colony producing a SCFV that has bound to the TAG-72 coated membrane. The advantage of using the FLAG system is that any Hum4 V_L - V_H SCFV combination that has bound to TAG-72 will be detected. Affinities can be measured by Scatchard analysis (Scatchard (1949), *supra*) and specificity by immunohistochemistry. These candidates could then be checked for binding to a specific epitope by using the competition assay, *supra*, and a competing antibody or mimetic, if desired.

10

15

20

The present invention is not to be limited in scope by the cell lines deposited since the deposited embodiment is intended as two illustration of one aspect of the invention and all cell lines which are functionally equivalent are within the scope of the invention. Indeed, while this invention has been described in detail and with reference to specific embodiments thereof, it will be apparent to one skilled in the art that various changes and modifications could be made therein without departing from the spirit and scope of the appended claims.

25

30

Claims

1. A composite Hum4 VL, VH antibody having binding affinity for TAG-72 comprising

5 A. a light chain having a variable region (VL), said VL being encoded by a DNA sequence encoding at least a portion of a light chain variable region effectively homologous to the human Subgroup IV germline gene (Hum4 VL); and

10 B. a heavy chain having a variable region (VH), said VH being encoded by a DNA sequence segment encoding at least a portion of a heavy chain variable region (VH) which is capable of combining with the VL to form a three dimensional structure having the ability to bind
15 TAG-72.

2. The composite Hum4 VL, VH antibody of Claim 1, wherein the VL is further encoded by a human J gene segment.

20 3. The composite Hum4 VL, VH antibody according to Claim 1, wherein the VH is encoded by a DNA sequence comprising a subsegment effectively homologous to the VH_HTAG germline gene (VH_HTAG).

25

4. The composite Hum4 VL, VH antibody of Claim 1, wherein the VH is further encoded by an animal D gene segment and an animal J gene segment.

5 Claim 1, wherein the variable region is derived from the variable regions of CC46, CC49, CC83 or CC92.

10 6. The composite Hum4 VL, VH antibody of Claim 1, wherein the VH comprises (1) complementarity diversity regions (CDR) being encoded by a gene derived from the VH α TAG. and (2) framework segments, adjacent to the CDR segments. encoded by a human genes.

15 7. The composite Hum4 VL, VH antibody of Claim 1, wherein the light chain further comprises at least a portion of a human light chain (C_L) and the heavy chain further comprises at least a portion of a animal constant region (C_H).

20 8. The composite Hum4 VL, VH antibody of Claim 6, wherein the C_H is IgG1-4, IgM, IgA1, IgA2, IgD or IgE.

25 9. The composite Hum4 VL, VH antibody of Claim 7, wherein C_L is kappa or lambda.

30 10. A composite Hum4 VL, VH single chain antibody or immunoreactive fragment thereof comprising (a) a light chain having a variable region (VL), said VL being encoded by a DNA sequence encoding at least a portion of a light chain variable region (VL) effectively homologous to the human Subgroup IV germline gene (Hum4 VL); (b) a heavy chain having a variable region (VH), said VH being encoded by a DNA sequence segment encoding at least a portion of a heavy chain

variable region (V_H) and (c) a linker linking the V_H and V_L , wherein the polypeptide linker properly folds the V_H and V_L into a single chain antibody which is capable of forming a three dimensional structure having the ability to bind TAG-

5 72.

11. A composite Hum4 V_L , V_H antibody conjugate comprising the composite Hum4 V_L , V_H antibody of Claims 1 through 10 conjugated to an imaging marker or a therapeutic agent.

10 12. The composite Hum4 V_L , V_H antibody conjugate of Claim 11, wherein the imaging marker is selected from the group consisting of ^{125}I , ^{131}I , ^{123}I , ^{111}In , ^{105}Rh , ^{153}Sm , ^{67}Cu , ^{67}Ga , ^{166}Ho , ^{177}Lu , ^{186}Re , ^{188}Re , and $^{99\text{m}}\text{Tc}$.

15 13. The composite Hum4 V_L , V_H antibody conjugate of Claim 11, wherein the therapeutic agent is a drug or biological response modifier, radionuclide, or toxin.

14. The composite Hum4 V_L , V_H antibody conjugate of Claim 13, wherein the drug is methotrexate, adriamycin or interferon.

20 15. The composite Hum4 V_L , V_H antibody conjugate of Claim 13, wherein the radionuclide is ^{131}I , ^{90}Y , ^{105}Rh , ^{47}Sc , ^{67}Cu , ^{212}Bi , ^{211}At , ^{67}Ga , ^{125}I , ^{186}Re , ^{188}Re , ^{177}Lu , $^{99\text{m}}\text{Tc}$, ^{153}Sm , ^{123}I or ^{111}In .

25 16. A composition comprising the composite Hum4 V_L , V_H antibody of Claim 1 in a pharmaceutically acceptable, non-toxic, sterile carrier.

17. A composition comprising the composite Hum4 VL, VH antibody of Claim 12 in a pharmaceutically acceptable, non-toxic, sterile carrier.

5 18. A composition comprising the composite Hum4 VL, VH antibody of Claim 13 in a pharmaceutically acceptable, non-toxic, sterile carrier.

10 19. A method for *in vivo* diagnosis of cancer which comprises administering to an animal a pharmaceutically effective amount of the composition of Claim 16 for the *in situ* detection of carcinoma lesions.

15 20. The method of Claim 19, wherein the animal is a human.

20 21. A method for the *in vivo* treatment of cancer which comprises administering to an animal a pharmaceutically effective amount of the composition of Claim 18.

22. The method of Claim 20, wherein the animal is a human.

25 23. A method for intraoperative therapy which comprises

30 (a) administering to an animal having at least one tumor a pharmaceutically effective amount of the composition of Claim 16, whereby the tumors are localized, and

(b) excising the tumors.

24. The method of Claim 23, wherein the animal is a human.

25. A cell capable of expressing the composite Hum4 V_L, V_H antibody or immunoreactive fragment thereof of Claim 1, said cell being transformed with

5 (A) a first DNA sequence encoding at least a portion of a light chain variable region (V_L) effectively homologous to the human Subgroup IV germline gene (Hum4 V_L); and

10 (B) a second DNA sequence encoding at least a portion of a heavy chain variable region (V_H) which is capable of combining with the V_L to form a three dimensional structure having the ability to bind TAG-72..

15 26. The cell of Claim 25 wherein the first and second DNA sequences are contained within at least one biologically functional expression vector.

20 27. A process for producing a composite Hum4 V_L, V_H antibody comprising at least the variable domains of the antibody heavy and light chains, in a single host cell, comprising the steps of:

25 A. transforming at least one host cell with

i) a first DNA sequence encoding at least a portion of a light chain variable region (V_L) effectively homologous to the human Subgroup IV germline gene (Hum4 V_L), and

30 ii) a second DNA sequence encoding at least a portion of a heavy chain variable region (V_H) which is capable of combining with the V_L to form a three dimensional structure having the ability to bind TAG-72, and

B. independently expressing said first DNA sequence and said second DNA sequence in said transformed single host cell.

28. The process according to Claim 27 wherein
5 said first and second DNA sequences are present in at least one vector.

29. The process according to Claim 28 wherein
10 the antibody heavy and light chains of the composite Hum4 VL, VH antibody are expressed in the host cell are secreted therefrom as an immunologically functional antibody molecule or antibody fragment.

30. The process of Claim 27, wherein the
15 second DNA sequence encodes the VH of CC46, CC49, CC83 or CC92.

31. A process for preparing an antibody or
antibody fragment conjugate which comprises contacting:
20 the composite Hum4 VL, VH antibody of Claim 1 with an imaging marker or therapeutic agent.

32. The process of Claim 31, wherein the
imaging marker is ^{125}I , ^{131}I , ^{123}I , ^{111}In , ^{105}Rh , ^{153}Sm ,
25 ^{67}Cu , ^{67}Ga , ^{166}Ho , ^{177}Lu , ^{186}Re , ^{188}Re or $^{99\text{m}}\text{Tc}$.

33. The process of Claim 32, wherein the
therapeutic agent is a radionuclide, drug or biological
response modifier, toxin or another antibody.
30

Fig. 1

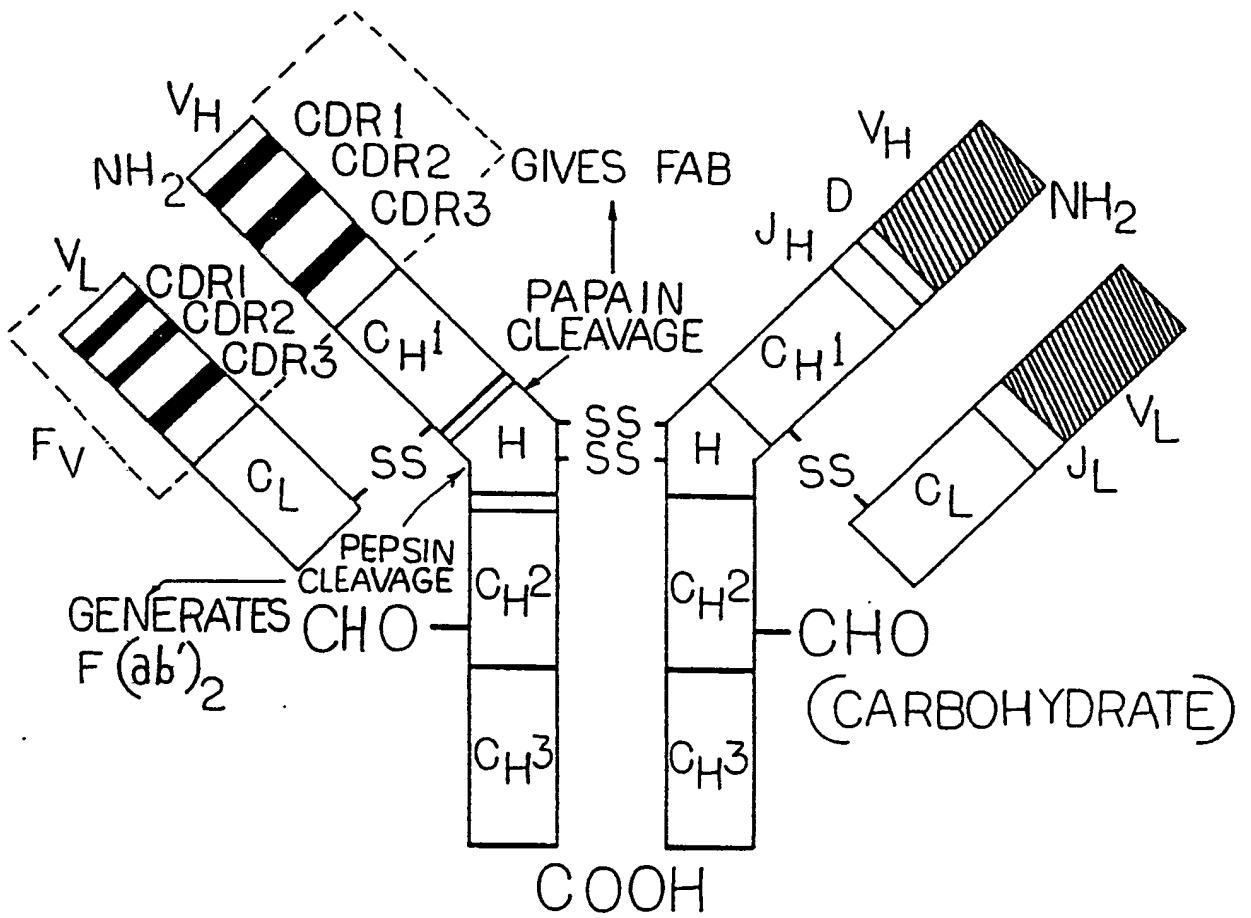

FIG. 2 (CONT.)

V _H αTAG	GCCCGAGCCA	TGTGATGACA	GTTCCTTCCTCC	AGTTGAAACTA
CC49
CC83
V _H αTAG	GGTCCTTATC	TAAGAAATGC	ACTGCTCATG	AAATATGCAAA
CC49
CC83
V _H αTAG	TCACCCGAGT	CTATGGCAGT	AAATACAGAG	ATGTTTCATAC
CC49
CC83
V _H αTAG	CATAAAAACA	ATATATGATC	AGTGTCTTCT	CCGCTATCCC
CC46
CC49G.....
CC83
CC92

FIG. 2 (CONT.)

V _H ^α TAG	TGGACACACT	GACTCTAACC	ATG GAA	TGG AGC	TGG
CC46
CC49
CC83
CC92
V _H ^α TAG	GTC TTT	CTC TTC	TTC CTG	TCA GTA	ACT ACA
CC46
CC49
CC83
CC92
V _H ^α TAG	GTAAGGGGCT	CACCATTTCC	AAATCTAAAG	TGGAGTCAGG	
CC46
CC49
CC83
CC92

FIG. 2 (CONT.)

V _H αTAG	GCCTGAGGTG	ACAAAGATAT	CACCTTTGGC	TTTCCACAG
CC46
CC49G.....G.....
CC83
CC92
V _H αTAG	GT GTC CAC TCC CAG GTT CAG CTG CAG CAG TCT			
CC46
CC49
CC83
CC92
V _H αTAG	GAC GCT GAG TTG GTG AAA CCT GGG GCT TCA GTG			
CC46
CC49
CC83
CC92

FIG. 2 (CONT.)

V _H αTAG	TGT AAA AGA CACAGTGTTG TAACCACATC CTGAGTGTGT	
CC46CG G.C GGC TAC GGG GTT GCT TTC TGG GGC	
CC49C. . . .TCC CTG AAT ATG GCC TAC TGG GGT	
CC83G. . . .TCC TTC TAC GGC AAC --- TGG GGC	
CC92C. . . .TCT CTA TCC GGG GAC TCC TGG GGC	← CDR3 →
V _H αTAG	CAGAAATCCT GGGGAGCAG AAAGATACAC TGGGACTGAG	
CC46	CAA GGG ACT CTG GTC ACT GTC TCT GCA G	
CC49	CAA GGA ACC TCA GTC ACC GTC TCC TCA G	
CC83	CAA GGC ACC ACC CTC ACA GTC TCC TCA G	
CC92	CAG GGC ACC ACT CTC ACA GTC TCC TCA G	
V _H αTAG	AAGACAGAAA AATTAATCCT TAGACTTGCT CAGAAATCGT	
V _H αTAG	AATTTGAAT GCCTATTTAT TTCATCTTGC TCACACACCT	
V _H αTAG	ATATTGCTTT TGTAAGCTT	

FIG. 2 (CONT.)

V _H α TAG	TGT AAA AGA CACAGTGTG TAACCACATC CTGAGTGTGT	
CC46CG G.C GGC TAC GGG TTT GCT TTC TGG GGC	
CC49C. ... TCC CTG AAT ATG GCC TAC TGG GGT	
CC83G. ... TCC TTC TAC GGC AAC --- TGG GGC	
CC92C. ... TCT CTA TCC GGG AAC TCC TGG GGC	
		← CDR3 →
V _H α TAG	CAGAAATCCT GGGGAGCAG AAAGATACAC TGGGACTGAG	
CC46	CAA GGG ACT CTG GTC ACT GTC TCT GCA G	
CC49	CAA GGA ACC TCA GTC ACC GTC TCC TCA G	
CC83	CAA GGC ACC ACC CTC ACA GTC TCC TCA G	
CC92	CAG GGC ACC ACT CTC ACA GTC TCC TCA G	
V _H α TAG	AAGACAGAAA AATTAATCCT TAGACTTGCT CAGAAATCCT	
V _H α TAG	AATTTGAAT GCCTATTTAT TTCATCTTGC TCACACACCT	
V _H α TAG	ATATTGCTTT TGTAAGCTT	

FIG. 3 (CONT.)

	CDR2										60
	Ser	Pro	Gly	Asn	Gly	Asp	Ile	Lys	Tyr	Asn	
VH α TAG
CC46	Asp	.	Phe
CC49	Asp
CC83	Asp
CC92	Asp

											70
	Glu	Lys	Phe	Lys	Gly	Lys	Ala	Thr	Leu	Thr	
VH α TAG
CC46	.	Arg
CC49
CC83
CC92

											80
	Ala	Asp	Lys	Ser	Ser	Ser	Thr	Ala	Tyr	Met	
VH α TAG
CC46
CC49	Val
CC83
CC92	.	.	.	Pro	.	Asn	.	Val	.	.	.

FIG. 3 (CONT.)

CC46	Gly	Thr	Leu	Val	Thr	Val	Ser	Ala
CC49	Gly	Thr	Ser	Val	Thr	Val	Ser	Ser
CC83	Gly	Thr	Thr	Leu	Thr	Val	Ser	Ser
CC92	Gly	Thr	Thr	Leu	Thr	Val	Ser	Ser

FIG. 3 (CONT.)

V _H αTAG	Gln	Leu	Asn	Ser	Leu	Thr	Ser	Glu	Asp	Ser
CC46	.	Phe
CC49
CC83
CC92

90

V _H αTAG	Ala	Val	Tyr	Phe	Cys	Lys	Arg
CC46	Thr	Gly
CC49	Thr	.
CC83	Arg	.
CC92	Thr	.

CC46	Gly	Tyr	Gly	Val	Ala	Phe	Trp	Gly	105
CC49	Ser	Leu	Asn	Met	Ala	Tyr	Trp	Gly	Gln
CC83	Ser	Phe	Tyr	Gly	Asn	-	Trp	Gly	Gln
CC92	Ser	Leu	Ser	Gly	Asp	Ser	Trp	Gly	Gln

← CDR3 →

FIG. 3 (CONT.)

V _H αTAG	Gln	Leu	Asn	Ser	Leu	Thr	Ser	Glu	Asp	Ser
CC46	.	Phe
CC49
CC83
CC92

	90									
V _H αTAG	Ala	Val	Tyr	Phe	Cys	Lys	Arg			
CC46	Thr	Gly			
CC49	Thr	.			
CC83	Arg	.			
CC92	Thr	.			

	CDR3										
	Gly	Tyr	Gly	Phe	Ala	Phe	Trp	Gly	Gln		105
CC46	Ser	Leu	Asn	Met	Ala	Tyr	Trp	Gly	Gln		
CC49	Ser	Phe	Tyr	Gly	Asn	-	Trp	Gly	Gln		
CC83	Ser	Leu	Ser	Gly	Asn	Ser	Trp	Gly	Gln		
CC92							Trp	Gly	Gln		

FIG. 4

1	5'	-GAA	TTC	Met	Glu	Lys	Leu	Trp	Phe
				ATG	GAA	AAA	CTT	TGG	TTC
7		Leu	Leu	Leu	Leu	Leu	Thr	Ile	Pro
25		TTG	CTT	CTG	CTG	CTG	ACC	ATC	CCT
15		Ser	Trp	Val	Leu	Ser	Gln	Ile	Thr
49		TCA	TGG	GTC	TTG	TCC	CAG	ATC	ACC
23		Leu	Lys	Glu	Ser	Gly	Pro	Thr	Leu
73		TTG	AAG	GAG	TCT	GGT	CCT	ACN	CTG
31		Val	Lys	Pro	Thr	Gln	Thr	Leu	Thr
97		GTG	AAA	CCC	ACA	CAG	ACC	CTC	ACG
37		Leu	Thr	Cys	Thr	Phe	Ser	Gly	Phe
121		CTG	ACC	TGC	ACC	TTC	TCT	GGG	TTC
47		Ser	Leu	Ser	Thr	His	Gly	Val	Gly
145		TCA	CTC	AGC	ACT	CAT	GGA	GTG	GGT
					← CDR1 →				
55		Val	Gly	Trp	Ile	Arg	xxx	xxx	Pro
169		GTG	GGC	TGG	ATC	CGT	NNN	NNC	CCA
63		Gly	Lys	Ala	Leu	Glu	Trp	Leu	Ala
193		GGA	AAG	GCC	CTG	GAG	TGG	CTT	GCA
					← CDR2 →				
71		Leu	Ile	Tyr	Trp	Asp	Asp	Asp	Lys
217		CTC	ATT	TAT	TGG	GAT	GAT	GAT	AAG
79		Arg	Tyr	Ser	Pro	Ser	Leu	Lys	Ser
241		CGC	TAC	AGC	CCA	TCT	CTG	AAG	AGC

FIG. 4 (CONT.)

87	Arg	Leu	Thr	Ile	Thr	Lys	Asp	Thr
265	AGG	CTC	ACC	ATC	ACC	AAG	GAC	ACC
95	Ser	Lys	Asn	Gln	Val	Ile	Leu	Thr
289	TCC	AAA	AAC	CAG	GTG	ATC	CTT	ACA
103	Met	Thr	Asn	Met	Asp	Pro	Val	Asp
313	ATG	ACC	AAC	ATG	GAC	CCT	GTG	GAC
111	Thr	Ala	Thr	Tyr	Tyr	Cys	Ala	His
337	ACA	GCC	ACA	TAT	TAT	TGT	GCA	CAC
	← CDR3 →							
119	Gly	Leu	Pro	Ser	Met	Val	Lys	Asn
361	GGG	CTG	CCA	TCT	ATG	GTT	AAG	AAC
127	Trp	Gly	Gln	Gly	Thr	Thr	Val	Thr
385	TGG	GGC	CAA	GGG	ACC	ACG	GTC	ACC
135	Val	Ser	Ser	Gly	Ser			
409	GTC	TCC	TCA	GGG	AGT-3'			

FIG. 4

1	5'-GAA	TTC	Met	Glu	Lys	Leu	Trp	Phe	
			ATG	GAA	AAA	CTT	TGG	TTC	
7	Leu	Leu	Leu	Leu	Leu	Thr	Ile	Pro	
25	TTG	CTT	CTG	CTG	CTG	ACC	ATC	CCT	
15	Ser	Trp	Val	Leu	Ser	Gln	Ile	Thr	
49	TCA	TGG	GTC	TTG	TCC	CAG	ATC	ACC	
23	Leu	Lys	Glu	Ser	Gly	Pro	Thr	Leu	
73	TTG	AAG	GAG	TCT	GGT	CCT	ACG	CTG	
31	Val	Lys	Pro	Thr	Gln	Thr	Leu	Thr	
97	GTG	AAA	CCC	ACA	CAG	ACC	CTC	ACG	
37	Leu	Thr	Cys	Thr	Phe	Ser	Gly	Phe	
121	CTG	ACC	TGC	ACC	TTC	TCT	GGG	TTC	
47	Ser	Leu	Ser	Thr	His	Gly	Val	Gly	
145	TCA	CTC	AGC	ACT	CAT	GGA	GTG	GGT	
				← CDR1 →					
55	Val	Gly	Trp	Ile	Arg	Gln	Pro	Pro	
169	GTG	GGC	TGG	ATC	CGT	CAG	CCC	CCA	
63	Gly	Lys	Ala	Leu	Glu	Trp	Leu	Ala	
193	GGA	AAG	GCC	CTG	GAG	TGG	CTT	GCA	
71	Leu	Ile	Tyr	Trp	Asp	Asp	Asp	Lys	
217	CTC	ATT	TAT	TGG	GAT	GAT	GAT	AAG	
				← CDR2 →					
79	Arg	Tyr	Ser	Pro	Ser	Leu	Lys	Ser	
241	CGC	TAC	AGC	CCA	TCT	CTG	AAG	AGC	

FIG. 5
 MOUSE GERMLINE J-H GENES
 FROM pNP9

```

5' -GGATCCTGGC CAGCATTGCC GCTAGGTCCC
    TCTCTTCTAT GCTTTCTTTG TCCCTCACTG
    GCCTCCATCT GAGATAATCC TGGAGCCCTA
    GCCAAGGATC ATTTATTGTC AGGGGTCTAA
    TCATTGTTGT CACAATGTGC CTGGTTTGCT
    TACTGGGGCC AAGGGACTCT GGTCACTGTC
    TCTGCAGGTG AGTCCTAACT TCTCCCATTG
    TAAATGCATG TTGGGGGGGAT TCTGAGCCTT
    CAGGACCAAG ATTCTCTGCA AACGGGAATC
    AAGATTCAAC CCCTTTGTCC CAAAGTTGAG
    ACATGGGTCT GGGTCAGGGA CTCTCTGCCT
    GCTGGTCTGT GGTGACATTA GAACTGAAGT
    ATGATGAAGG ATCTGCCAGA ACTGAAGCTT
    GAAGTCTGAG GCAGAATCTT GTCCAGGGTC
    TATCGGACTC TTGTGAGAAT TAGGGGCTGA
    CAGTTGATGG TGACAATTTC AGGGTCAGTG
    ACTGTCAGGT TTCTCTGAGG TGAGGCTGGA
    ATATAGGTCA CCTTGAAGAC TAAAGAGGGG
    TCCAGGGGCT TTTCTGCACA GGCAGGGAAC
    AGAATGTGGA ACAATGACTT GAATGGTTGA
    TTCTTGTGTG ACACCAAGAA TTGGCATAAT
    GTCTGAGTTG CCCAAGGGTG ATCTTAGCTA
    AAAACCCACT ATTGTGATTA CTATGCTATG
    GACTACTGGG GTCAAGGAAC CTCAGTCACC
    GTCTCCTCAG GTAAGAATGG CCTCTCCAGG
    TCTTTATTTT TAACCTTTGT TATGGAGTTT
    TCTGAGCATT GCAGACTAAT CTTGGATATT
    TGCCCTGAGG GAGCCGGCTG AGAGAAGTTG
    GGAAATAAAT CTGTCTAGGG ATCTCAGAGC
    CTTTAGGACA GATTATCTCC ACATCTTTGA
    AAAACTAAGA ATCTGTGTGA TGGTGTGGT
    GGAGTCCCTG GATGATGGGA TAGGGACTTT
  
```

FIG. 5 (CONT.)

GGAGGCTCAT	TTGAGGGAGA	TGCTAAAACA
ATCCTATGGC	TGGAGGGATA	GTTGGGGCTG
TAGTTGGAGA	TTTTTCAGTTT	TTAGAATGAA
GTATTAGCTG	CAATACTTCA	AGGACCACCT
CTGTGACAAC	CATTTTATAC	AGTATCCAGG
CATAGGGACA	AAAAGTGGAG	TGGGGCACTT
TCTTTAGATT	TGTGAGGAAT	GTTCCACACT
AGATTGTTTA	AAACTTCATT	TGTTGGAAGG
AGCTGTCTTA	GTGATTGAGT	CAAGGGAGAA
AGGCATCTAG	CCTCGGTCTC	AAAAGGGTAG
TTGCTGTCTA	GAGAGGTCTG	GTGGAGCCTG
CAAAAGTCCA	GCTTTCAAAG	GAACACAGAA
GTATGTGTAT	GGAATATTAG	AAGATGTTGC
TTTTACTCTT	AAGTTGGTTC	CTAGGAAAAA
TAGTTAAATA	CTGTGACTTT	AAAATGTGAG
AGGGTTTTCA	AGTACTCATT	TTTTTAAATG
TCCAAAATTT	TTGTCAATCA	ATTTGAGGTC
TTGTTTGTGT	AGAACTGACA	TTACTTAAAG
TTTAACCGAG	GAATGGGAGT	GAGGCTCTCT
CATACCCTAT	TCAGAACTGA	CTTTTAACAA
TAATAAATTA	AGTTTAAAAT	ATTTTTAAAT
GAATTGAGCA	ATGTTGAGTT	GAGTCAAGAT
GGCCGATCAG	AACCGGAACA	CCTGCAGCAG
CTGGCAGGAA	GCAGGTCATG	TGGCAAGGCT
ATTTGGGGAA	GGGAAAATAA	AACCACTAGG
TAAACTTGTA	GCTGTGGTTT	GAAGAAGTGG
TTTTGAAACA	CTCTGTCCAG	CCCCACCAA
CCGAAAGTCC	AGGCTGAGCA	AAACACCACC
TGGGTAATTT	GCATTTCTAA	AATAAGTTGA
GGATTCAGCC	GAAACTGGAG	AGGTCCTCTT
TTAACTTATT	GAGTTCAACC	TTTTAATTTT
AGCTTGAGTA	GTTCTAGTTT	CCCCAACTT
AAGTTTATCG	ACTTCTAAA	TGTATTTAGA
ATTC-3'		

Fig. 6

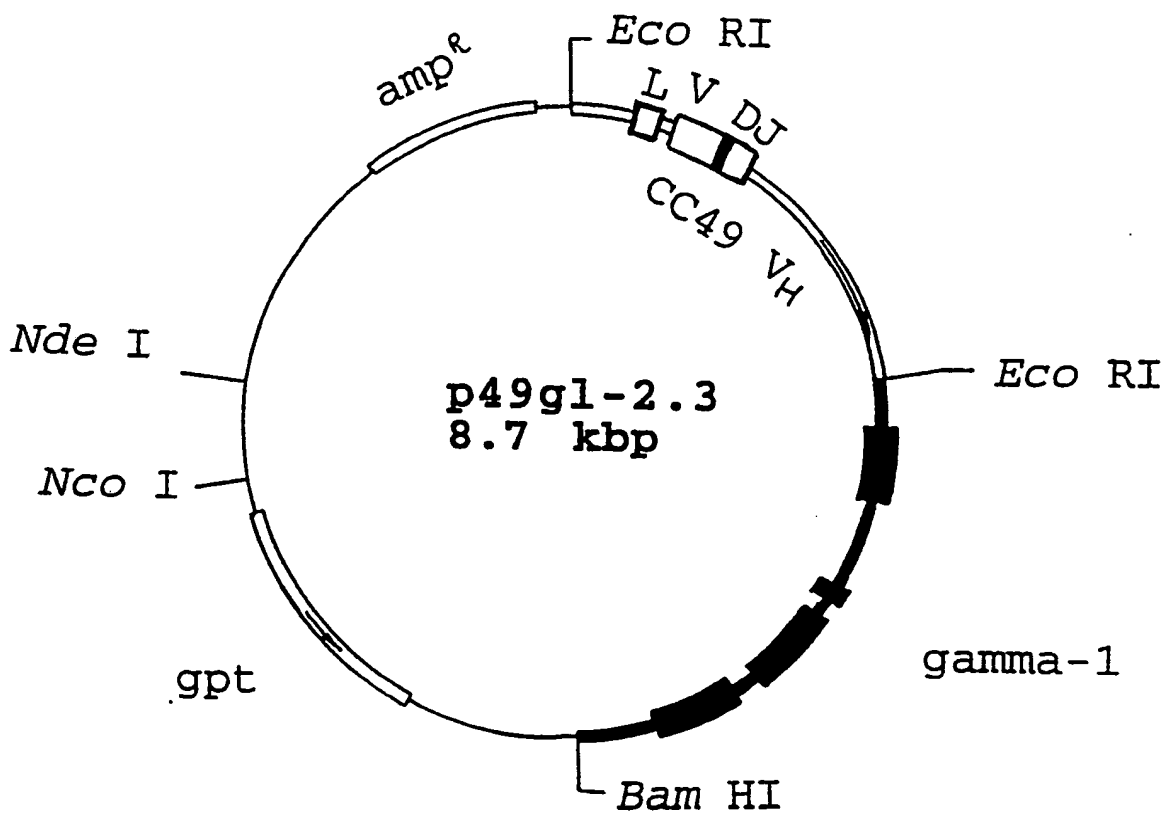

FIG. 7

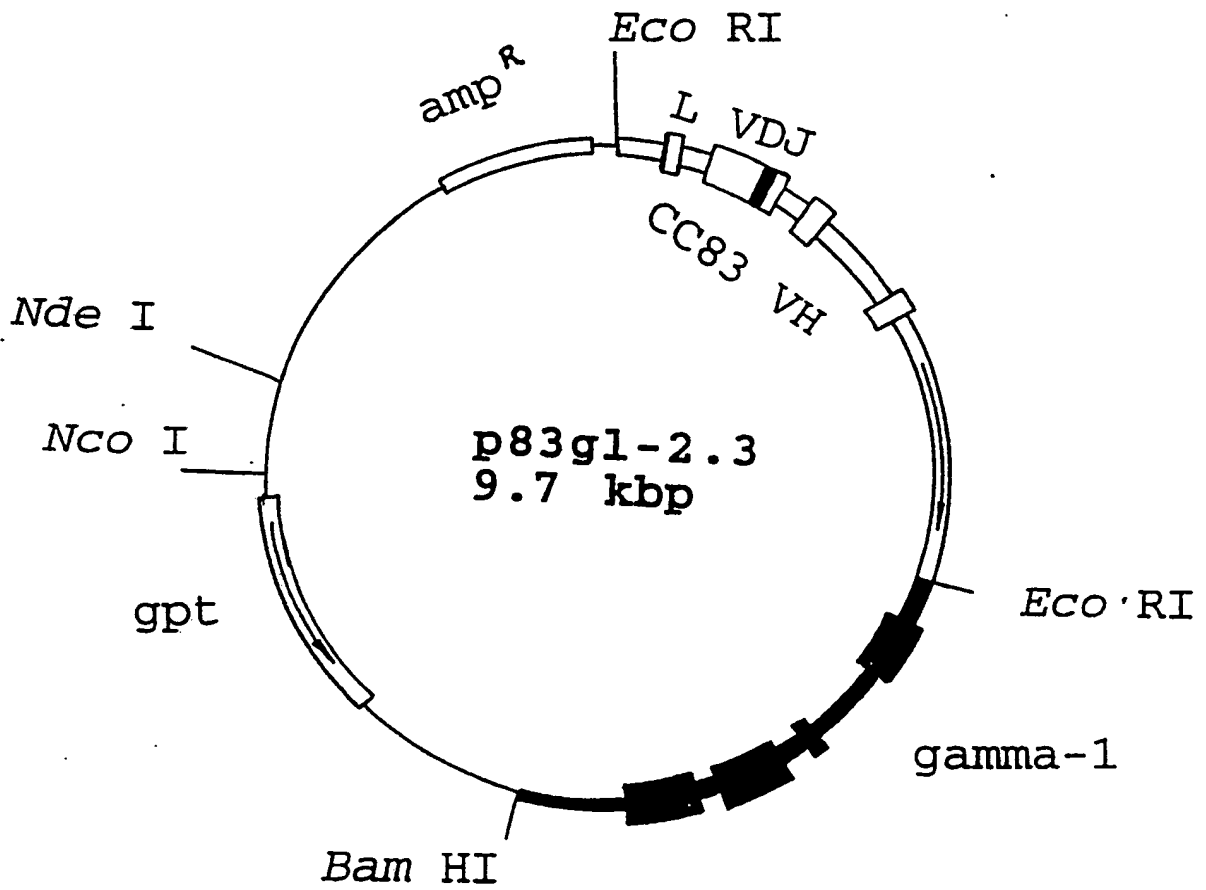

FIG. 8

HUMVL (+), 26-MER:

(Cla I)

5' - GAAGAGTATC GATAAAATTT ATTGAG - 3'

HUMVL (-), 98-MER:

(SPLICE SITE)

(Hind III)

5' - CATT**AAGCTT** AGAAAAGTGT ACTTACGTTT
 GATCACCACC TTGGTCCCTC CGCCGAAAGT
 GAGAGGATAA CTATAATATT GCTGACAGTA
ATAAACTG - 3'

FIG. 9

HJ4:

Leu Thr Phe Gly Gly Gly Thr Lys
CTC ACT TTC GGC GGA GGG ACC AAG

Val Glu Ile Lys A↓(rg)
GTG GAG ATC AAA C GTAAGTGCAC

TTTCCTAA

FIGURE 9: Human J4 (HJ4) amino acid and DNA sequences. The first two amino acids (Leu-Thr) complete the CDR3 region, the remainder make up the FR4 region. The (↓) indicates the splice site and the beginning of the intron between the J and C exons. DNA sequence underlined in HJ4 represents a part of the sequence used for the 3' end PCR oligo HUMVL(-).

FIG. 10

Cla I

5' ATCGATAAAA TTTATTGAGA ATTTGTTTAT TATGATTAAC 3418
 3' TAGCTATTTT AAATAACTCT TAAACAAATA ATACTAATTG
 AGAGGTAAA GCCAGTATAT TACTGATTAA TATAGGTAAG 3458
 TCTCCATTTT
 * CGGTCATATA ATGACTAATT ATATCCATTT
 AGGCAGTTAA GAAATTGGGA ATGCTTTCTC TTCGTGCTTTC 3498
 TCCGTCAATT CTTTAACCCCT TACGAAAGAG AAGACGAAAG
 TTCTACGATG CACAAGGCGT TTCACATTTA TGCCCCATATG 3538
 AAGATGCTAC GTGTTCCGCA AAGTGTAAT ACGGGGATAC
 AAAATTACTA GGCTGTCCCTA GTCATTAGAT CTTTCAGCAG 3578
 TTTTAATGAT CCGACAGGAT CAGTAATCTA GAAAGTCGTC
 TTTGTAGTTT TAGAGCTTCT AAGTTGACTT CTGTCTTTC 3618
 AAACATCAA ATCTCGAAGA TTCAACTGAA GACAGAAAAG
 TATTCATACA ATTACACATT CTGTGATGAT ATTTTGGCT 3658
 ATAAGTATGT TAATGTGTAA GACACTACTA TAAAACCCGA

HUMLIN1 (-)

FIG. 10 (CONT.)

CTTGATTTAC ATTGGGTACT TTCACAACCC ACTGCTCATG 3698
 GAACATAAATG TAACCCATGA AAGTGTGGG TGACCGAGTAC

AAATTGCTT TTGTACTACT GGTGTGTTTT GCATAGGCC 3738
 TTTAAACGAA AACATGATGA CCAACAATAA CGTATCCGGG

CTCCAGGCCA CGACCAGGTG TTGGATTTT ATAAACGGGC 3778
 GAGGTCCGGT GCTGGTCCAC AAACCTATAA TATTGCCCCG

CGTTTGCAAT GTGAACTGAG CTACAACAGG CAGGCAGGG 3818
 GCAAACGTAA CACTTGACTC GATGTTGTCC GTCCGTCCCC

Met Val Leu Gln Thr Gln Val Leu Ile -10
 CAGCAAG ATG GTG TTG CAG ACC CAG GTC TTC ATT 3852
 GTCGTTT TAC CAC AAC GTC TGG GTC CAG AAG TAA

Ser Leu Leu Leu Trp Ile Ser G Intron
 TCT CTG TTG CTC TGG ATC TCT G GTGA GGAATTAAA -4
 AGA GAC AAC GAG ACC TAG AGA C CACT CCTTAATTTT 3888

AGTGCCACAG TCTTTTCAGA GTAATATCTG TGTAGAAATA
 TCACGGTGTC AGAAAAGTCT CATTATAGAC ACATCTTTAT

HUMLIN2 (-)

FIG. 10 (CONT.)

AAAAAAATTA AGATATAGTT GGAAATAATG ACTATTCCCA
 TTTT'TTTAAT TCTATATCAA CCTTTATTAC TGATAAAGGT
 Bam HI
 ATATGGATCC AATTATCTGC TGACTTATAA TACTACTAGA
 TATACCTAGG TTAATAGACG ACTGAATATT ATGATGATCT

 AAGCAAATTT AAATGACATA TTTCAATTAT ATCTGAGACA
 TTCGTTTAAA TTTACTGTAT AAAGTTAATA TAGACTCTGT

 GCGTGATATA GTTTATGTAT AATCATTGTC CATTACTGAC
 CGCACATATT CAAATACATA TTAGTAACAG GTAATGACTG

 TACAG
 ATGTC

+1
 ly Ala Tyr Gly Asp Ile Val Met Thr Gln Ser
 GT GCC TAC GGG GAC ATC ATC GTG ATG ACC CAG TCT
 CA CGG ATG CCC CTG TAG CAC TAC TGG GTC AGA

7
4125

FIG. 10 (CONT.)

Pro	Asp	Ser	Leu	Ala	Val	Ser	Leu	Gly	Glu	Arg	Ala	Thr	20
CCA	GAC	TCC	CTG	GCT	GTG	TCT	CTG	GGC	GAG	AGG	GCC	ACC	4164
GGT	CTG	AGG	GAC	CGA	CAC	AGA	GAC	CCG	CTC	TCC	CGG	TGG	
Ile	Asn	Cys	Lys	Ser	Ser	Gln	Ser	Val	Leu	Tyr	Ser	Ser	27F
ATC	AAC	TGC	AAG	TCC	AGC	CAG	AGT	GTT	TTA	TAC	AGC	TCC	4203
TAG	TTG	ACG	TTC	AGG	TCG	GTC	TCA	CAA	AAT	ATG	TCG	AGG	
Asn	Asn	Lys	Asn	Tyr	Leu	Ala	Trp	Tyr	Gln	Gln	Lys	Pro	40
AAC	AAT	AAG	AAC	TAC	TTA	GCT	TGG	TAC	CAG	CAG	AAA	CCA	4242
TTG	TTA	TTC	TTG	ATG	AAT	CGA	ACC	ATG	GTC	GTC	TTT	GGT	
Gly	Gln	Pro	Pro	Lys	Leu	Leu	Ile	Tyr	Trp	Ala	Ser	Thr	53
GGA	CAG	CCT	CCT	AAG	CTG	CTC	ATT	TAC	TGG	GCA	TCT	ACC	4281
CCT	GTC	GGA	GGA	TTC	GAC	GAG	TAA	ATG	ACC	CGT	AGA	TGG	
Arg	Glu	Ser	Gly	Val	Pro	Asp	Arg	Phe	Ser	Gly	Ser	Gly	66
CGG	GAA	TCC	GGG	GTC	CCT	GAC	CGA	TTC	AGT	CGC	AGT	CGC	4320
GCC	CTT	AGG	CCC	CAG	GGA	CTG	GCT	AAG	TCA	CCG	TCG	CCC	
Ser	Gly	Thr	Asp	Phe	Thr	Leu	Thr	Ile	Ser	Ser	Leu	Gln	Ala
TCT	GGG	ACA	GAT	TTC	ACT	CTC	ACC	ATC	AGC	AGC	CTG	CAG	GCT
AGA	CCC	TGT	CTA	AAG	TGA	GAG	TGG	TAG	TCG	TCG	GAC	GTC	CGA

CDR1

HUMLCDR1 (-)

CDR2

FIG. 10 (CONT.)

Glu	ASP	Val	Ala	Val	Tyr	Tyr	Cys	Gln	Gln	Tyr	Tyr	Ser	93
GAA	GAT	GTG	GCA	GTT	TAT	TAC	TGT	CAG	CAA	TAT	TAT	AGT	4400
CTT	CTA	CAC	CGT	CAA	ATA	ATG	ACA	GTC	GTT	ATA	ATA	TCA	
Tyr	Pro	Leu	Thr	Phe	Gly	Gly	Gly	Thr	Lys	Val	Val	Ile	106
TAT	CCT	CTC	ACT	TTC	GGC	GGA	GGG	ACC	AAG	GTG	GTG	AAA	4440
ATA	GGA	GAG	TGA	AAG	CCG	CCT	CCC	TGG	TTC	CAC	CAC	TAG	
Lys	A(rg)												107
AAA	C	GTAAGTACAC	TTTTTCTAAG	CTT-3'	<i>Hind</i>	III							4466
TTT	G	CATTTCATGTG	AAAAGATTTC	GAA 5'									

CDR3

FIG. 10 (CONT.)

FIGURE 10: Entire DNA sequence of the Hum4 V gene *Cla* I-*Hind* III segment in pRL1001, Clone #2. A single base difference occurred at position 3461 and is marked with an asterisk (*). The corresponding amino acid sequences in the coding exons are shown. The site of the Leu-Pro mutation in Clone #7 is boxed. An arrow () indicates the site of the single base deletion in Clone #11. Oligonucleotides used as primers for the sequencing reactions are underlined. In order as they occur from the 5' end are: HUMLIN1(-), HUMLIN2(-), HUMLCDR1(-) and *Hind* III Ck(-) (not shown).

FIG. 11

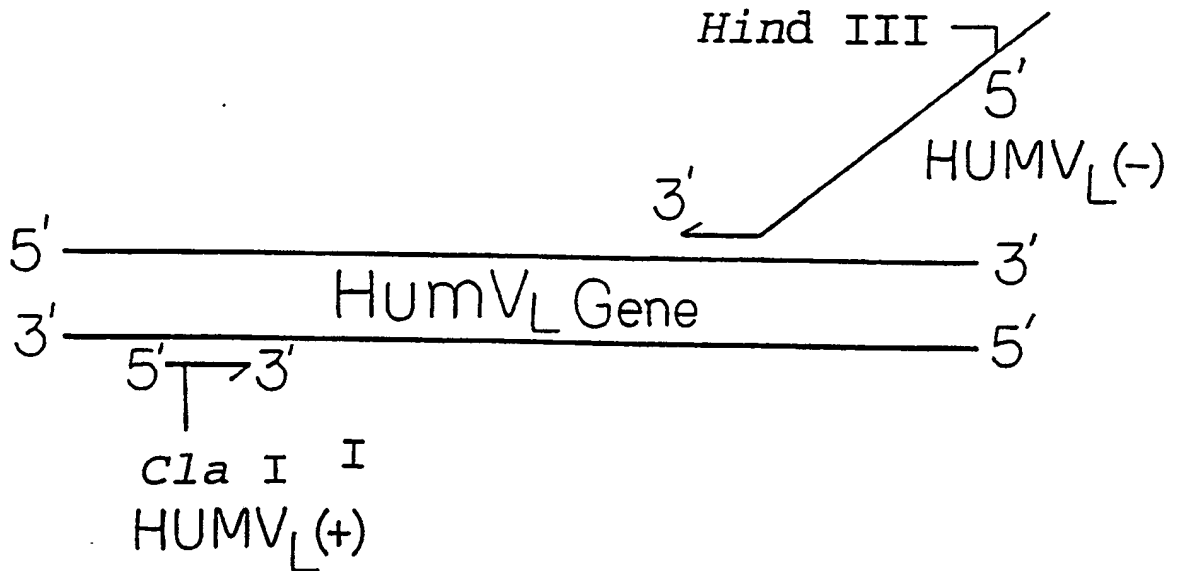

A schematic representation of the human germline Subgroup IV gene (HumVL) as the target for the PCR. The 5'-end oligo (HUMVL(+)) and the 3'end oligo (HUMVL(-)) used to prime the elongation reactions for Taq polymerase are shown with half-arrows to indicate the direction of synthesis.

FIG. 12

1 2 3 4 5 6 7 8

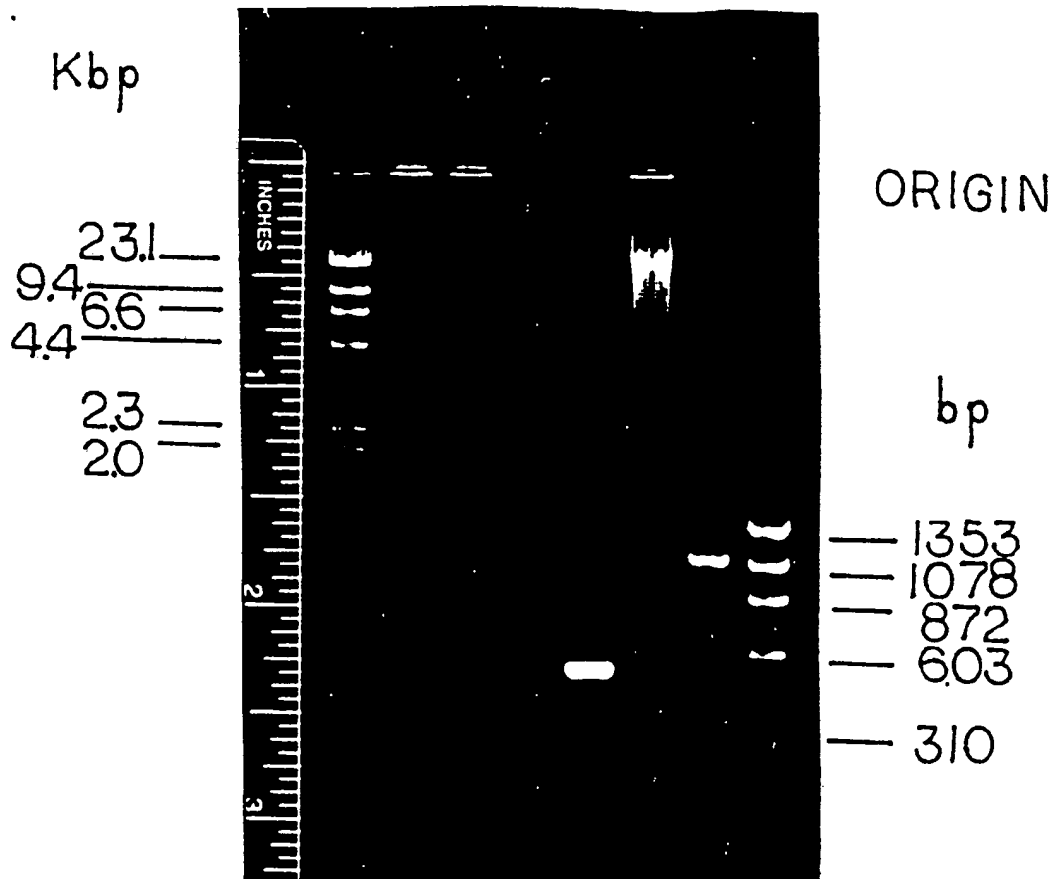

FIGURE 12: Agarose gel electrophoresis of Hum4V_L PCR reactions. Lane 1: λ Hind III standard; lane 2: no Taq polymerase control; lane 3: no primers added; lane 4: no human DNA template; lane 5: Gene Amp kit positive control; lane 6: 3 μ g human DNA with primers and Taq polymerase; lane 7: same as lane 6, but with 1 μ g human DNA and lane 8: ϕ X174-Hae III DNA standard. Ethidium bromide was added to the gel and buffer. Bands were visualized by long wavelength UV light.

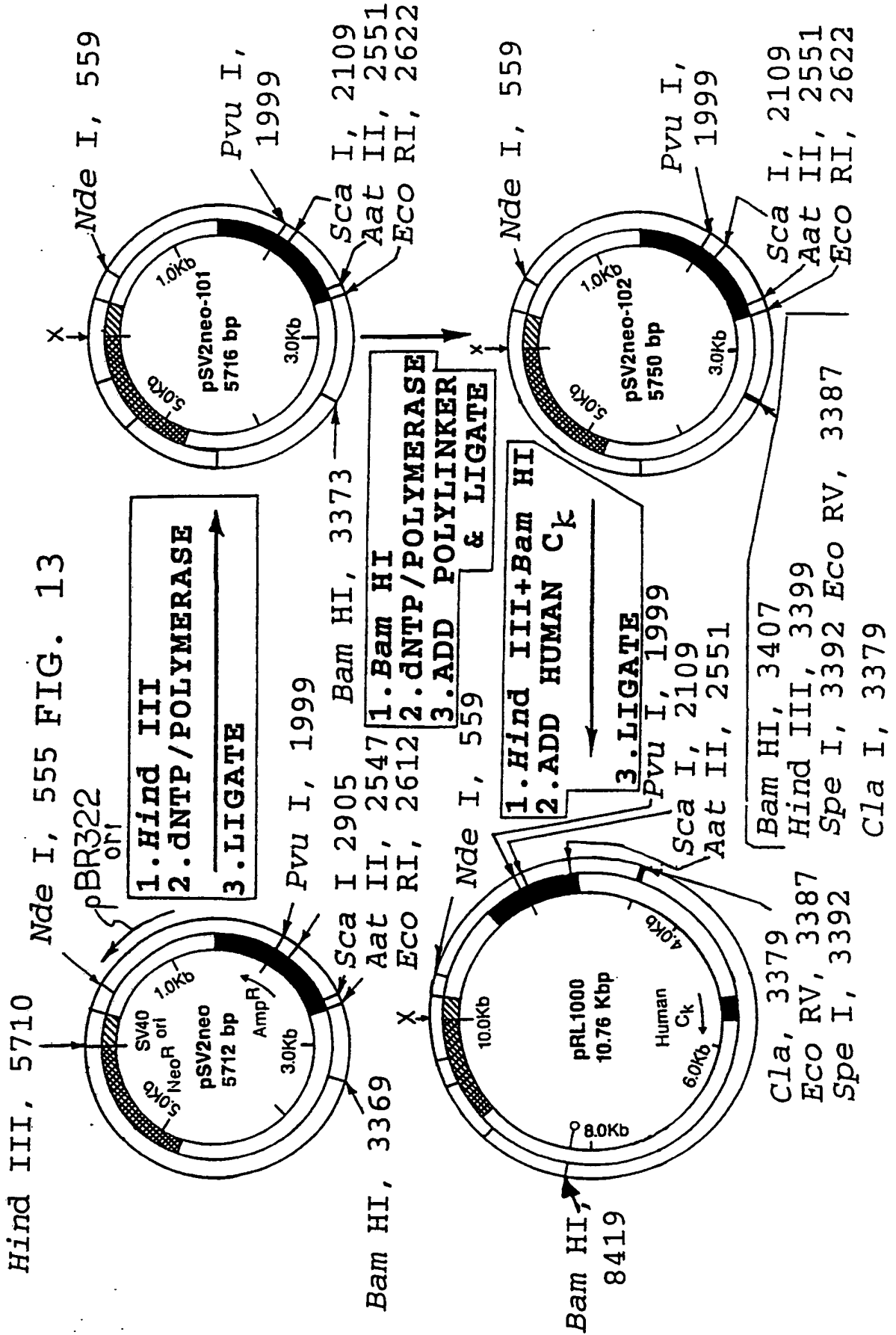

FIG. 14

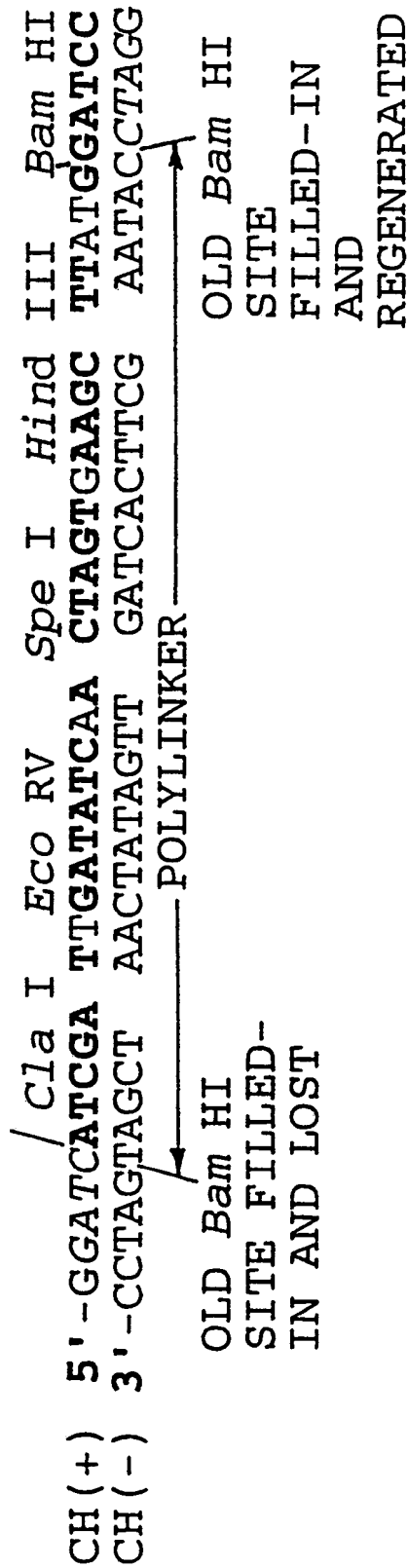

FIGURE 14: The polylinker inserted between filled-in Bam HI site of pSV2neo-101 to create pSV2neo-102. Note that the polylinker could be inserted in both orientations such that the Bam HI site on the left side could also be regenerated (and the one on the right side lost). The nucleotides used to fill-in the Bam HI site are shown in italics. The top synthetic oligo was called CH(+) while the complementary strand was CH(-).

FIG. 15

(A portion of the DNA
Sequence of pSV2neo)

← TOWARDS *Eco* RI SITE 5'-GAGGAGGTTA
GGGTTTATGA GGACACAGAG GAGCTTCCTG
 GGGATCCAGA CATGATAAGA TACATTGATG
Bam HI
 AGTTTGGACA AACCACAACT AGA-3'

FIGURE 15: Oligonucleotide synthesized (21-mer, called NEO102SEQ) to sequence putative pSV2neo-102 clones is the underlined sequence shown above. The *Bam* HI site where the polylinker was inserted in pSV2neo-101 is boxed.

FIG. 16

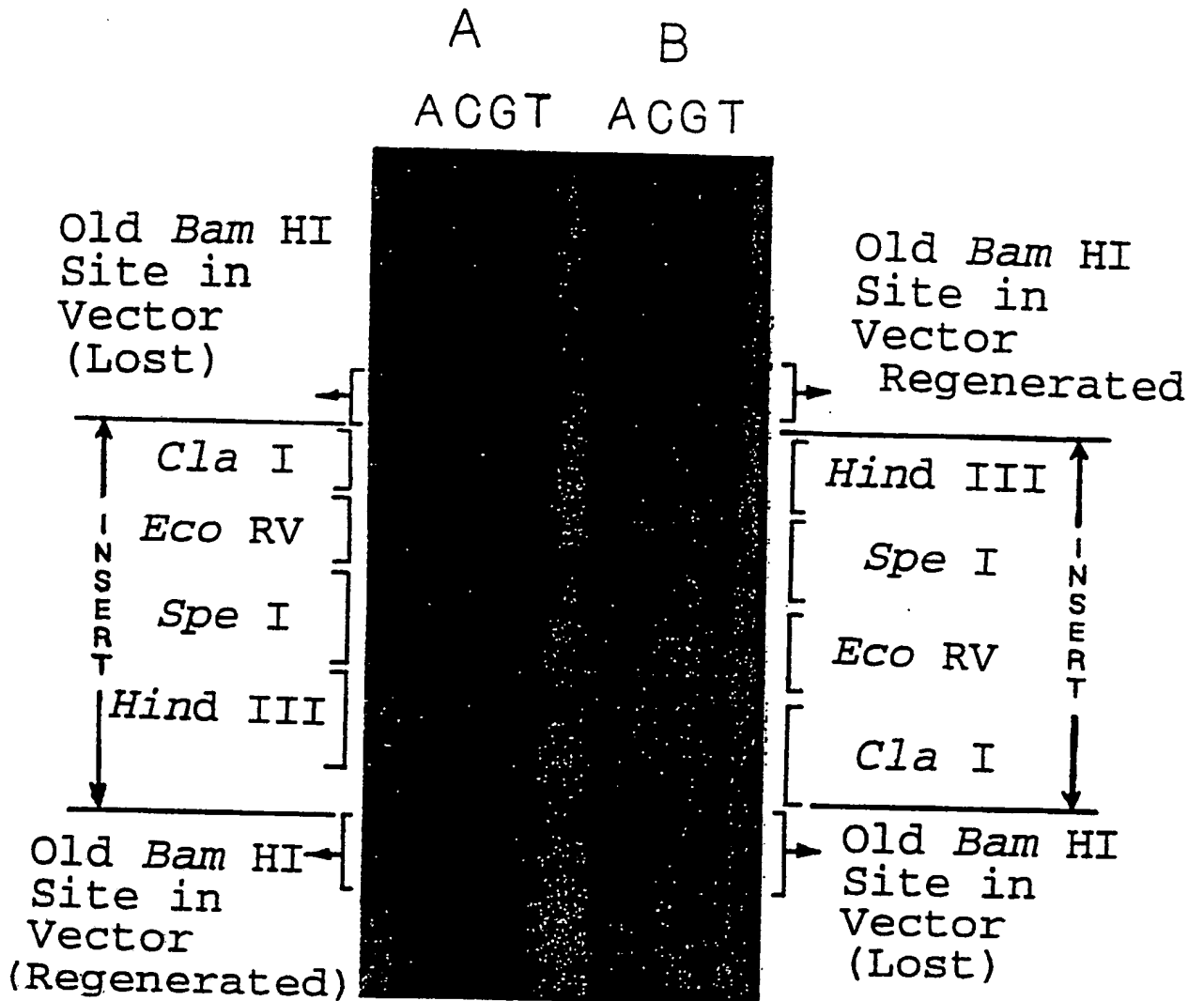

FIGURE 16: P-32 autoradiogram showing polylinker DNA sequence cloned in *Bam* HI site of pSV2neo-101. In both cases a single 30-base linker unit was incorporated, but in opposite orientations. Panel A-Sequence resulting in pSV2neo-120; Panel B-sequence resulting in pSV2neo-102. Reading the sequence (going up) is in the 5' to 3' direction of the (+) strand.

FIG. 17

LOST *Bam* HI
 SITE IN
 pSV2neo

5' -CTTCCTGGGG ATCATCGATT GATATCAACT 3394

Cla I *Eco* RV *Spe* I

FROM HUMAN C
Hind III - *Bam* HI INSERT

Hind III
AGTTGAAGCT TTTTTTTTTT CAGTGCTATT 3423
TAATTATTTC AATATCCTCT CATCAAATGT 3453
 ATTTAAATAA CAAAAGCTCA ACCAAAAAGA 3483
 AAGAAATATG TAATTCTTTC AGAGTAAAAA 3513
 TCACACCCAT GACCTGGCCA CTGAGGGGCTT 3543
 GATCAATTCA CTTTGAATTT GGCATTAAAT 3573
 ACCATTAAGG TATATTA ACT GATTTTAAAA 3603
TOWARDS
 TAAGATATAT TCGTGACC-3' *Bam* HI 3621

FIGURE 17: DNA sequence from pRL1000, reading the (+) strand from the primer NEO102SEQ (Figure 15). Sequence data past the *Hind* III site is from the human C κ *Hind* III - *Bam* HI insert. The sequence complementary to the underlined DNA sequence, called *Hind* III C κ (-), was synthesized as a primer for sequencing in the upstream 3' direction.

FIG. 18

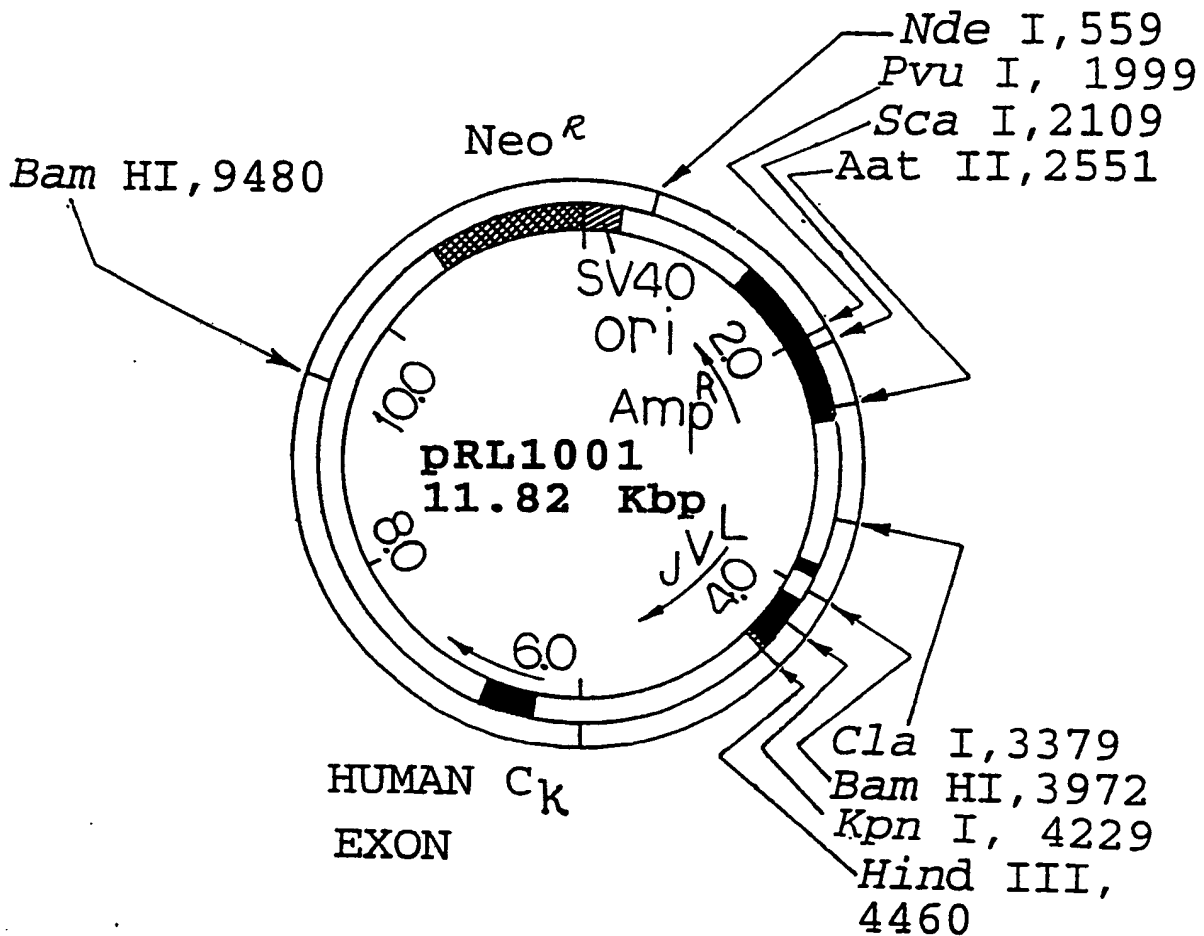

FIGURE 18: Partial restriction map of the plasmid pRL1001. This is the expression vector to introduce the human anti-tumor L chain gene in Sp2/0 cells.

FIG. 19

DNA SEQUENCING - ρ RL1001

FIGURE 19: DNA sequence autoradiogram of pRL1001 clones. Reading the gel is in the 5' to 3' direction on the (-) strand, from the *Hind* III C_k (-) primer. Clones 2 and 9 were equivalent to the expected sequence, clone 7 had a single base substitution (marked by *) and clone 11 had a single base deletion (marked by -).

Fig. 20

RECIPROCAL COMPETITION BETWEEN
CC49, Ch44, AND Ch44H

INHIBITION OF BINDING OF I-125 CC49 TO TAG72

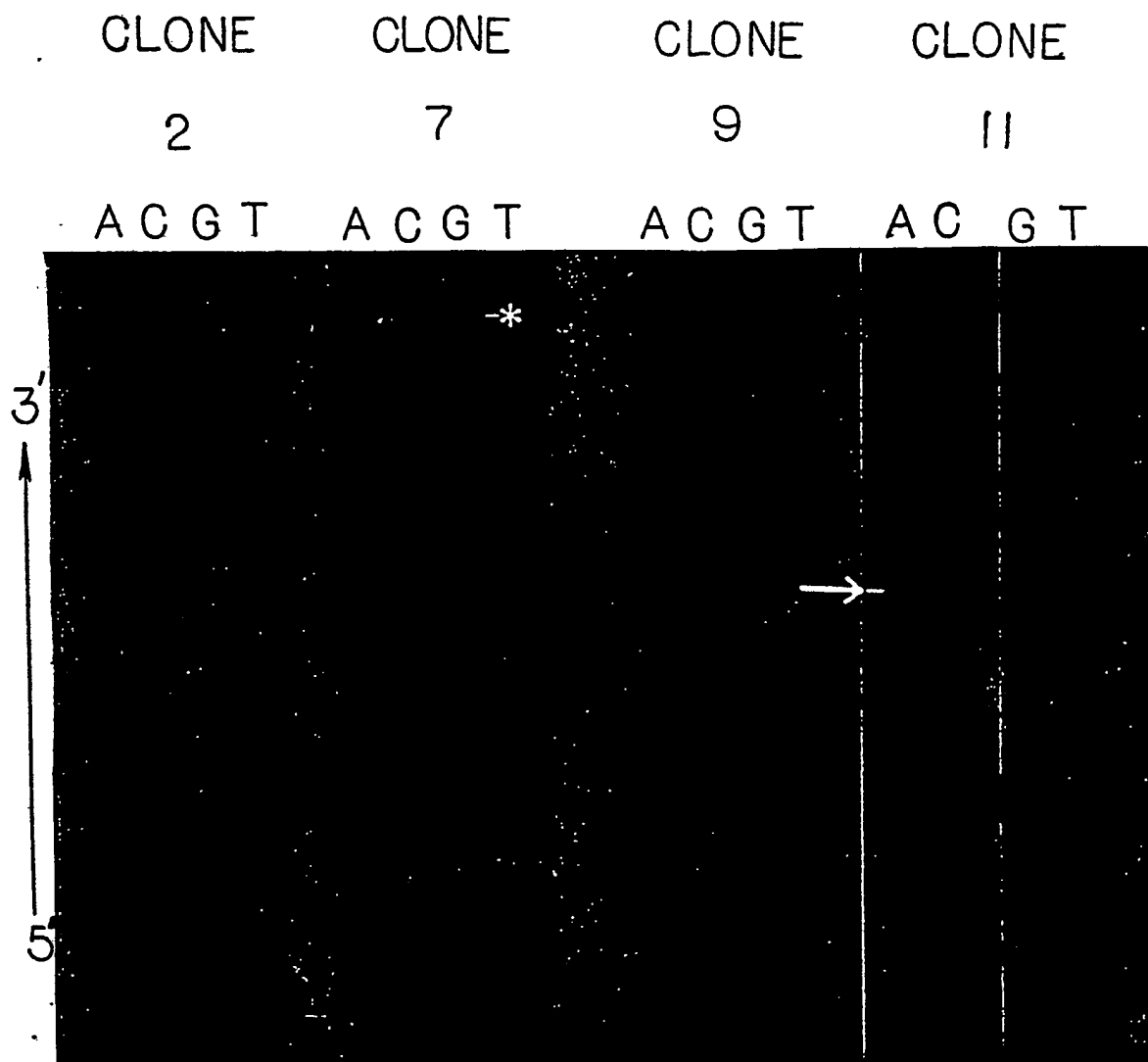
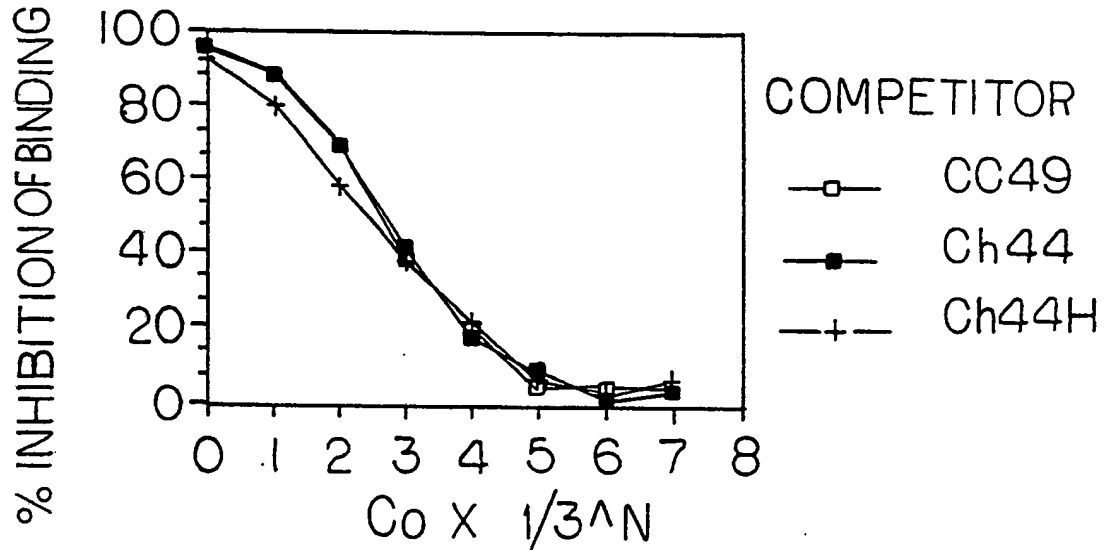

INHIBITION OF BINDING OF I-125 Ch44 TO TAG-72

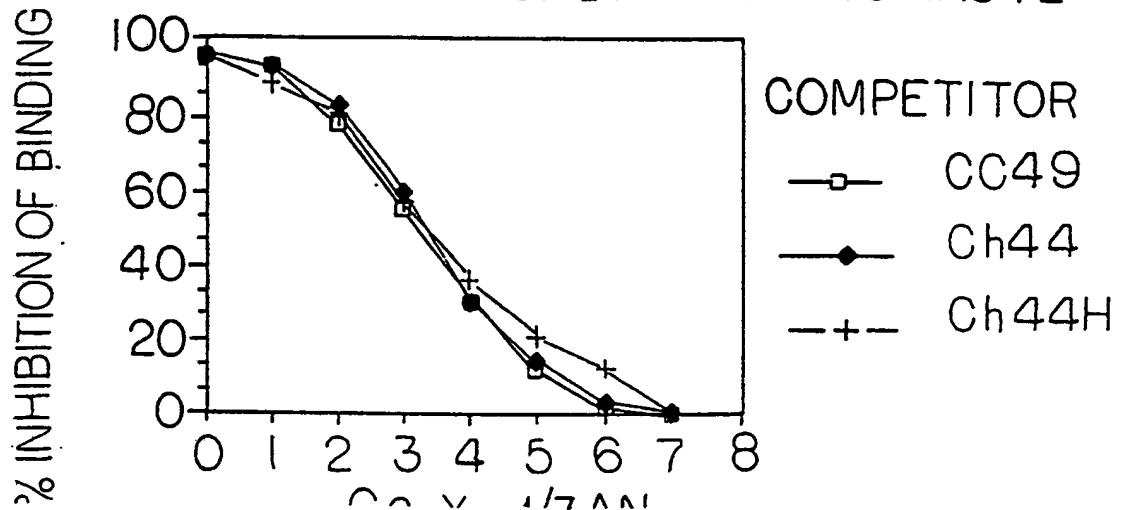

Fig. 20 (CONT.)

RECIPROCAL COMPETITION BETWEEN
CC49, Ch44, AND Ch44H

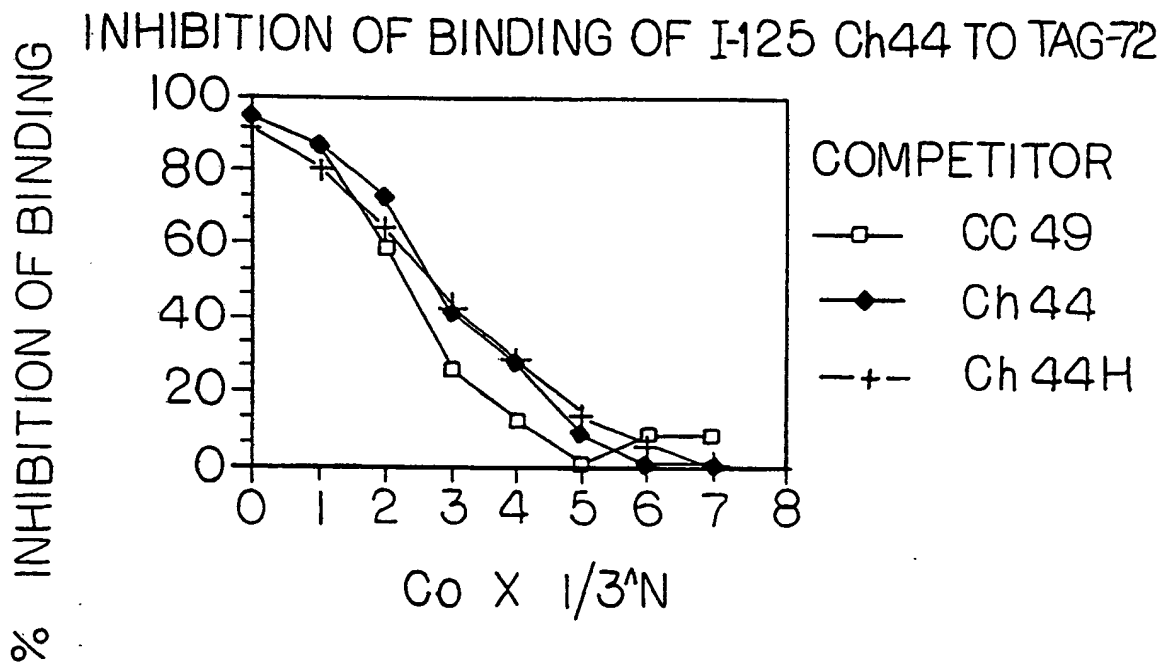

FIG. 21

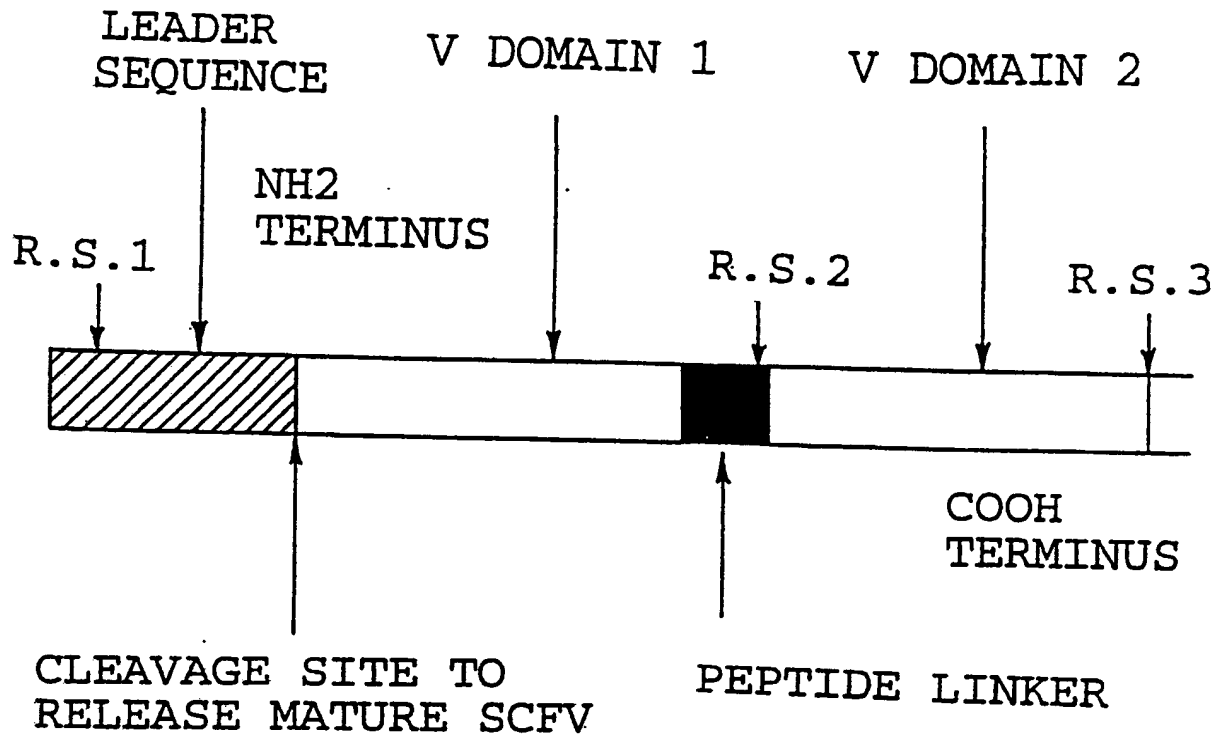

FIG. 22

							Met	Leu
							AAA	ACTAT AAGCTCCATG ATG CTT
Leu	Gln	Ala	Phe	Leu	Phe	Leu	Leu	Ala
TTG	CAA	GCT	TTC	CTT	TTC	CTT	TTG	GCT
Gly	Phe	Ala	Ala	Lys	Ile	Ser	Ala	Asp
GGT	TTT	GCA	GCC	AAA	ATA	TCT	GCA	GAC
Ile	Val	Met	Thr	Gln	Ser	Pro	Asp	Ser
ATC	GTG	ATG	ACC	CAG	TCT	CCA	GAC	TCC
Leu	Ala	Val	Ser	Leu	Gly	Glu	Arg	Ala
CTG	GCT	GTG	TCT	CTG	GGC	GAG	AGG	GCC
Thr	Ile	Asn	Cys	Lys	Ser	Ser	Gln	Ser
ACC	ATC	AAC	TGC	AAG	TCC	AGC	TGC	AAG
CDR1L ←								
Val	Leu	Tyr	Ser	Ser	Asn	Asn	Lys	Asn
GTT	TTA	TAC	AGC	TCC	AAC	AAT	AAG	AAC
Tyr	Leu	Ala	Trp	Tyr	Gln	Gln	Lys	Pro
TAC	TTA	GCT	TGG	TAC	CAG	CAG	AAA	CCA
Gly	Gln	Pro	Pro	Lys	Leu	Leu	Ile	Tyr
GGA	CAG	CCT	CCT	AAG	CTG	CTC	ATT	TAC
CDR2L ←								
Trp	Ala	Ser	Thr	Arg	Glu	Ser	Gly	Val
TGG	GCA	TCT	ACC	CGG	GAA	TCC	GGG	GTC
Pro	Asp	Arg	Phe	Ser	Gly	Ser	Gly	Ser
CCT	GAC	CGA	TTC	AGT	GGC	AGC	GGG	TCT

FIG. 22 (CONT.)

Gly	Thr	Asp	Phe	Thr	Leu	Thr	Ile	Ser		
GGG	ACA	GAT	TTC	ACT	CTC	ACC	ATC	AGC		
Ser	Leu	Gln	Ala	Glu	Asp	Val	Ala	Val		
AGC	CTG	CAG	GCT	GAA	GAT	GTG	GCA	GTT		
Tyr	Tyr	Cys	← CDR3L						Ser	Tyr
TAT	TAC	TGT	Gln	Gln	Tyr	Tyr	AGT	TAT		
			CAG	CAA	TAT	TAT				
Pro	Leu	Thr	Phe	Gly	Gly	Gly	Thr	Lys		
CCT	CTC	ACT	TTC	GGC	GGA	GGG	ACC	AAG		
Val	Lys	Glu	Ser	Gly	Ser	Val	Ser	Ser		
GTG	AAG	GAG	TCA	GGT	TCG	GTC	TCC	TCA		
LINKER										
Glu	Gln	Leu	Ala	Gln	Phe	Arg	Ser	Leu		
GAA	CAA	TTG	GCC	CAA	TTT	CGT	TCC	TTA		
Asp	Val	Gln	Leu	Gln	Gln	Ser	Asp	Ala		
GAC	GTC	CAG	TTG	CAG	CAG	TCT	GAC	GCT		
Glu	Leu	Val	Lys	Pro	Gly	Ala	Ser	Val		
GAG	TTG	GTG	AAA	CCT	GGG	GCT	TCA	GTG		
Lys	Ile	Ser	Cys	Lys	Ala	Ser	Gly	Tyr		
AAG	ATT	TCC	TGC	AAG	GCT	TCT	GGC	TAC		
Thr	Phe	Thr	← CDR1H						His	Trp
ACC	TTC	ACT	Asp	His	Ala	Ile	CAC	TGG		
			GAC	CAT	GCA	ATT				
Val	Lys	Gln	Asn	Pro	Glu	Gln	Gly	Leu		
GTG	AAA	CAG	AAC	CCT	GAA	CAG	GGC	CTG		

FIG. 22 (CONT.)

Glu	Trp	Ile	Gly	Tyr	Phe	Ser	Pro	Gly
GAA	TGG	ATT	GGA	TAT	TTT	TCT	CCC	GGA
CDR2H								
Asn	Asp	Asp	Phe	Lys	Tyr	Asn	Glu	Arg
AAT	GAT	GAT	TTT	AAA	TAC	AAT	GAG	AGG
Phe	Lys	Gly	Lys	Ala	Thr	Leu	Thr	Ala
TTC	AAG	GGC	AAG	GCC	ACA	CTG	ACT	GCA
Asp	Lys	Ser	Ser	Ser	Thr	Ala	Tyr	Val
GAC	AAA	TCC	TCC	AGC	ACT	GCC	TAC	GTG
Gln	Leu	Asn	Ser	Leu	Thr	Ser	Glu	Asp
CAG	CTC	AAC	AGC	CTG	ACA	TCT	GAG	GAT
Ser	Ala	Val	Tyr	Phe	Cys	Thr	Arg	Ser
TCT	GCA	GTG	TAT	TTC	TGT	ACA	AGA	TCC
CDR3H								
Leu	Asn	Met	Ala	Tyr	Trp	Gly	Gln	Gly
CTG	AAT	ATG	GCC	TAC	TGG	GGT	CAA	GGA
Thr	Ser	Val	Thr	Val	Ser			
ACC	TCA	GTC	ACC	GTC	TCC	TAG	TGA	

AGCTTGGAAC ACCACACAAA CCATATCCAA A

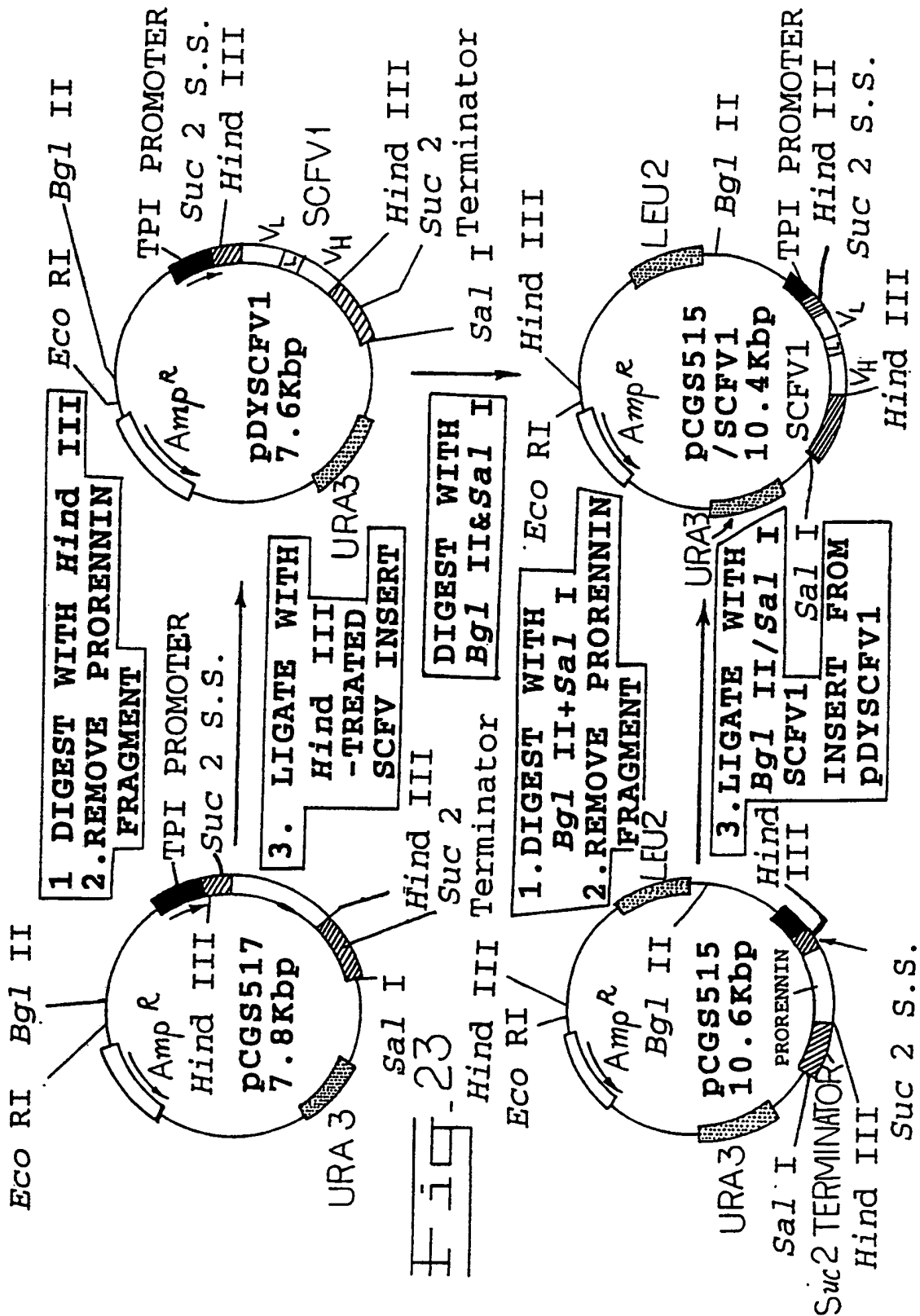

Fig. 24

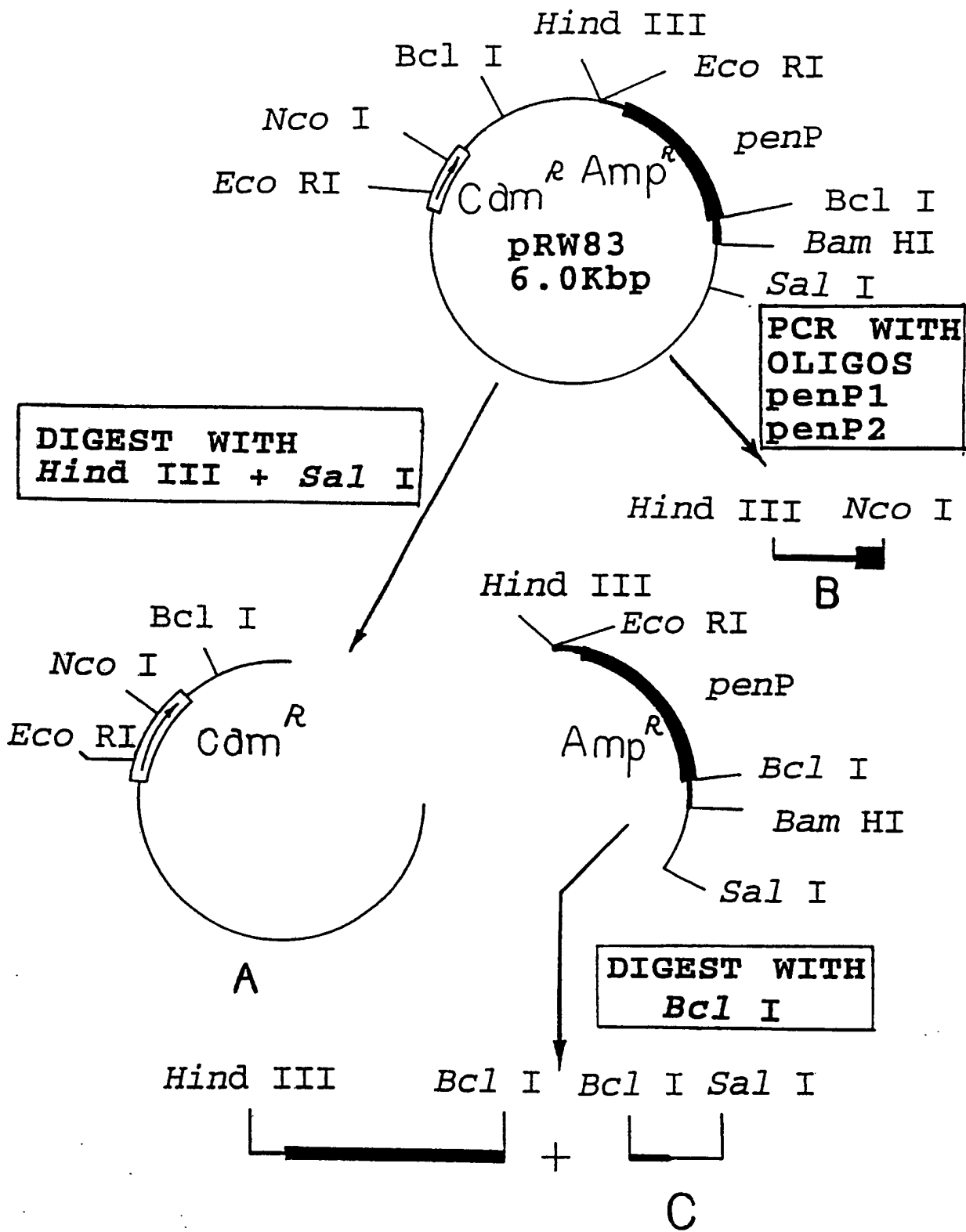
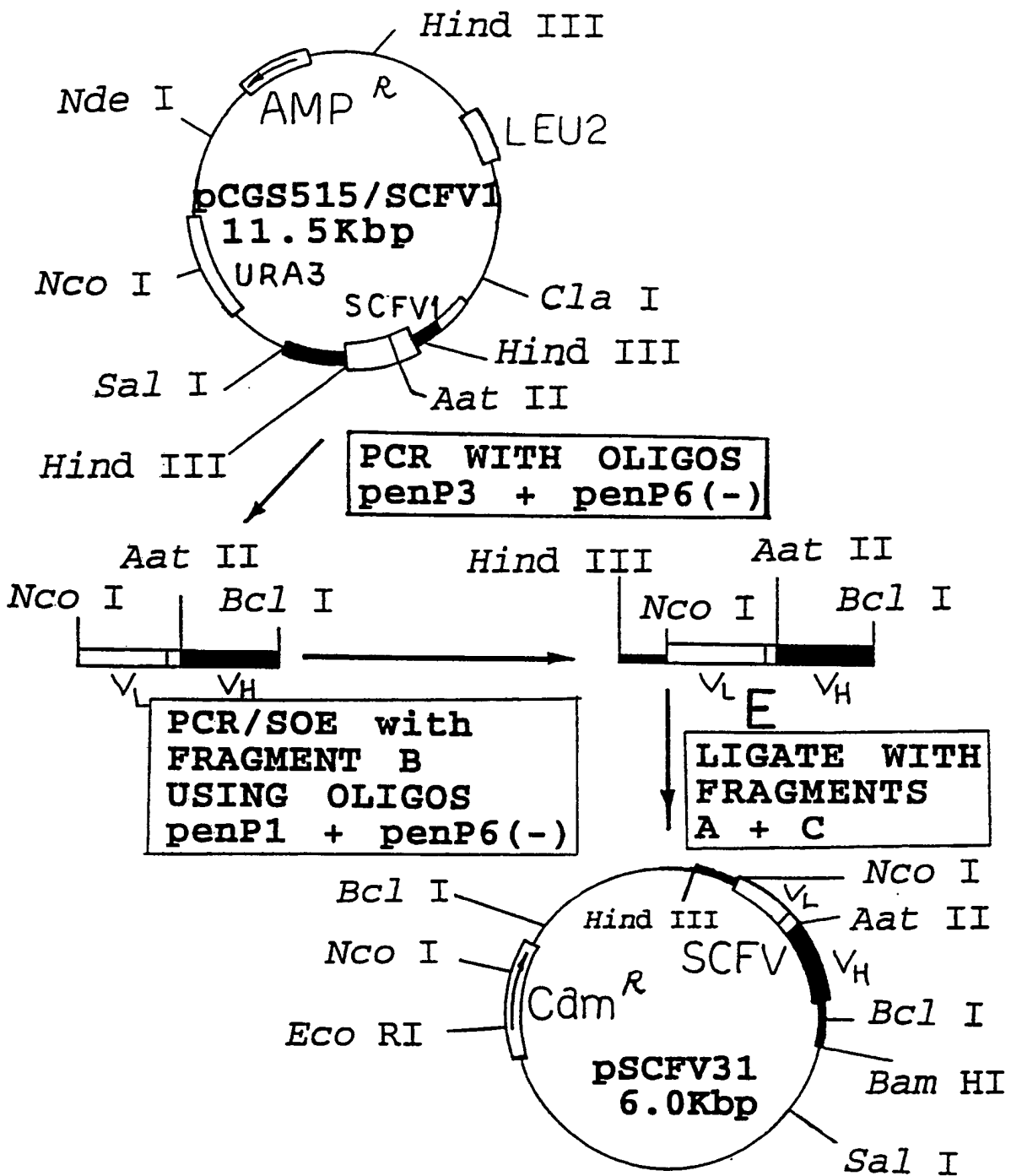

Fig. 24 (CONT.)



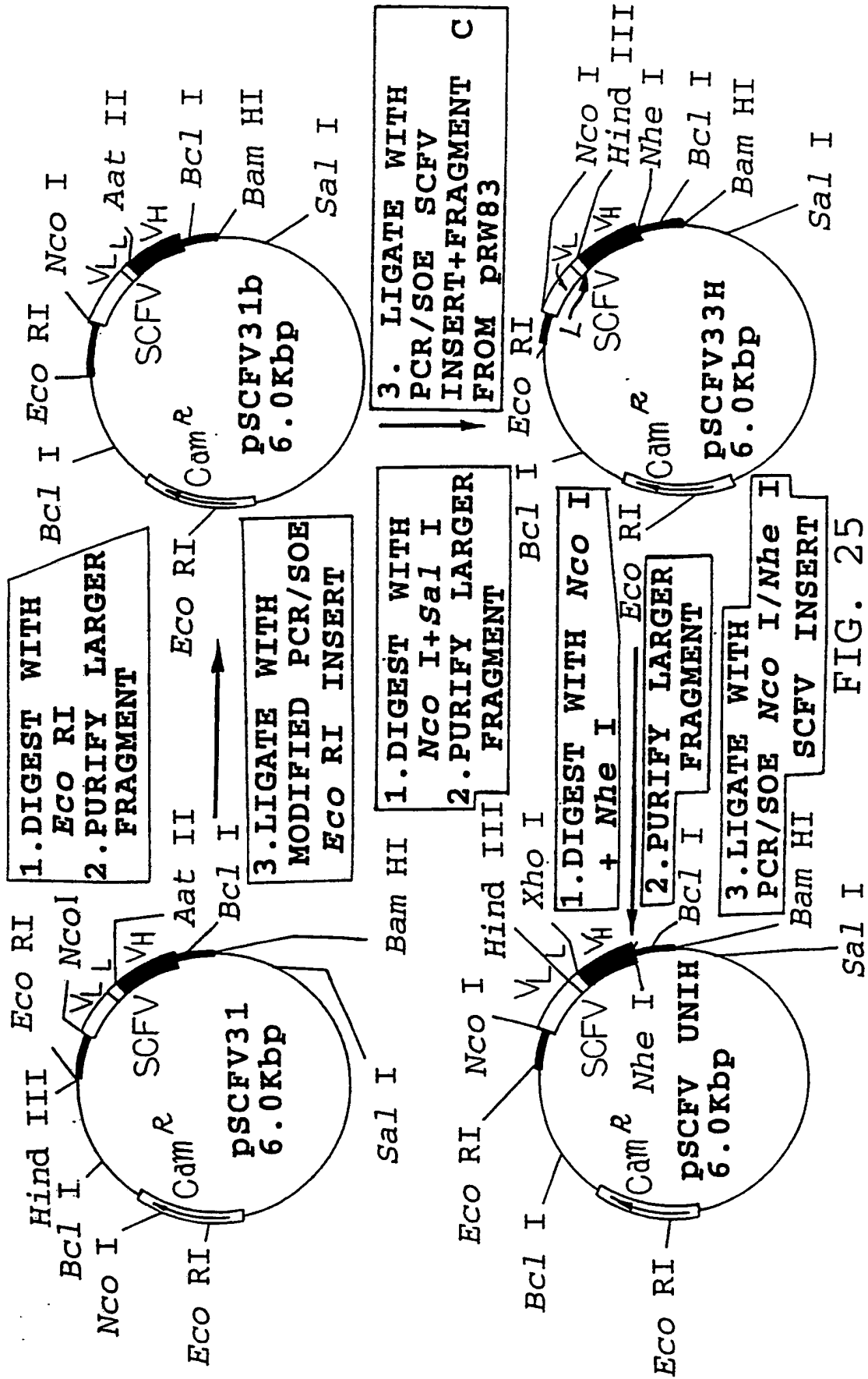

FIG. 25

FIG. 26

Eco RI

CTCATGTTTG ACAGCTTATC ATCGATGAAT
 TCCATCACTT CCCTCCGTTT ATTTGTCCCC
 GGTGGAAACG AGGTCATCAT TTCCTTCCGA
 AAAAACGGTT GCATTTAAAT CTTACATATG
 TAATACTTTC AAAGACTACA TTTGTAAGAT
 TTGATGTTTG AGTCGGCTGA AAGATCGTAC
 GTACCAATTA TTGTTTCGTG ATTGTTCAAG
 CCATAACACT GTAGGGATAG TGGAAAGAGT
 GCTTCATCTG GTTACGATCA ATCAAATATT

pelB Signal

CAAACGGAGG GAGACGATTT TG | Met Lys Tyr Leu
 Sequence | ATG AAA TAC CTA

Leu Pro Thr Ala Ala Ala Gly Leu Leu Leu
 TTG CCT ACG GCA GCC GCT GGA TTG TTA TTA

Nco I → ← **H4V_L**

Leu Ala Ala Gln Pro Ala Met Ala | Asp Ile
 CTC GCT GCC CAA CCA GCC ATG GCC | GAC ATC

Val Met Thr Gln Ser Pro Asp Ser Leu Ala
 GTG ATG ACC CAG TCT CCA GAC TCC CTG GCT

Val Ser Leu Gly Glu Arg Ala Thr Ile Asn
 GTG TCT CTG GGC GAG AGG GCC ACC ATC AAC

Cys Lys Ser Ser Gln Ser Val Leu Tyr Ser
 TGC AAG TCC AGC CAG AGT GTT TTA TAC AGC

FIG. 26 (CONT.)

Ser Asn Asn Lys Asn Tyr Leu Ala Trp Tyr
TCC AAC AAT AAG AAC TAC TTA GCT TGG TAC

Gln Gln Lys Pro Gly Gln Pro Pro Lys Leu
CAG CAG AAA CCA GGA CAG CCT CCT AAG CTG

Leu Ile Tyr Trp Ala Ser Thr Arg Glu Ser
CTC ATT TAC TGG GCA TCT ACC CGG GAA TCC

Gly Val Pro Asp Arg Phe Ser Gly Ser Gly
GGG GTC CCT GAC CGA TTC AGT GGC AGC GGG

Ser Gly Thr Asp Phe Thr Leu Thr Ile Ser
TCT GGG ACA GAT TTC ACT CTC ACC ATC AGC

Ser Leu Gln Ala Glu Asp Val Ala Val Tyr
AGC CTG CAG GCT GAA GAT GTG GCA GTT TAT

Tyr Cys Gln Gln Tyr Tyr Ser Tyr Pro Leu
TAC TGT CAG CAA TAT TAT AGT TAT CCT CTC

Thr Phe Gly Gly Gly Thr Lys Val Val Ile
ACT TTC GGC GGA GGG ACC AAG GTG GTG ATC

Hind III LINKER

Lys | Leu Ser Ala Asp Asp Ala Lys Lys Asp
AAG | CTT AGT GCG GAC GAT GCG AAA AAG GAT

Ala Ala Lys Lys Asp Asp Ala Lys Lys Asp
GCT GCG AAG AAG GAT GAC GCT AAG AAA GAC

LINKER Xho I CC49 V_H

Asp Ala Lys Lys Asp Leu | Glu Val Gln Leu
GAT GCT AAA AAG GAC CTC | GAG GTT CAG TTG

FIG. 26 (CONT.)

Gln	Gln	Ser	Ala	Glu	Leu	Val	Lys	Pro	Gly
CAG	CAG	TCT	GCT	GAG	TTG	GTG	AAA	CCT	GGG
Ala	Ser	Val	Lys	Ile	Ser	Cys	Lys	Ala	Ser
GCT	TCA	GTG	AAG	ATT	TCC	TGC	AAG	GCT	TCT
Gly	Tyr	Thr	Phe	Thr	Asp	His	Ala	Ile	His
GGC	TAC	ACC	TTC	ACT	GAC	CAT	GCA	ATT	CAC
Trp	Val	Lys	Gln	Asn	Pro	Glu	Gln	Gly	Leu
TGG	GTG	AAA	CAG	AAC	CCT	GAA	CAG	GGC	CTG
Glu	Trp	Ile	Gly	Tyr	Phe	Ser	Pro	Gly	Asn
GAA	TGG	ATT	GGA	TAT	TTT	TCT	CCC	GGA	AAT
Asp	Asp	Phe	Lys	Tyr	Asn	Glu	Arg	Phe	Lys
GAT	GAT	TTT	AAA	TAC	AAT	GAG	AGG	TTC	AAG
Gly	Lys	Ala	Thr	Leu	Thr	Ala	Asp	Lys	Ser
GGC	AAG	GCC	ACA	CTG	ACT	GCA	GAC	AAA	TCC
Ser	Ser	Thr	Ala	Tyr	Val	Gln	Leu	Asn	Ser
TCC	AGC	ACT	GCC	TAC	GTG	CAG	CTC	AAC	AGC
Leu	Thr	Ser	Glu	Asp	Ser	Ala	Val	Tyr	Phe
CTG	ACA	TCT	GAG	GAT	TCT	GCA	GTG	TAT	TTC
Cys	Thr	Arg	Ser	Leu	Asn	Met	Ala	Tyr	Trp
TGT	ACA	AGA	TCC	CTG	AAT	ATG	GCC	TAC	TGG
Gly	Gln	Gly	Thr	Ser	Val	Thr	Val	Ser	Ser
GGT	CAA	GGA	ACC	TCA	GTC	ACC	GTC	TCC	TCA

CC49 V_H →

FIG. 26 (CONT.)

Nhe I

TAA AAAGCTAGCG ATGAATCCGT CAAAACATCA

Bcl ITCTTACATAA AGTCACTTGG **TGATCAAGCT**

CATATCATTG TCCGGCAATG GTGTGGGCTT

TTTTTGTTTT CTATCTTTAA AGATCATGTG

AAGGAAAAAA CGGGAAAATC GGTCTGCGGG

AAAGGACCGG GTTTTTGTCG AAATCATAGG

Bam HICGAATGGGTT GGATTGTGAC AAAATTCGGA **TCC**

FIG. 27

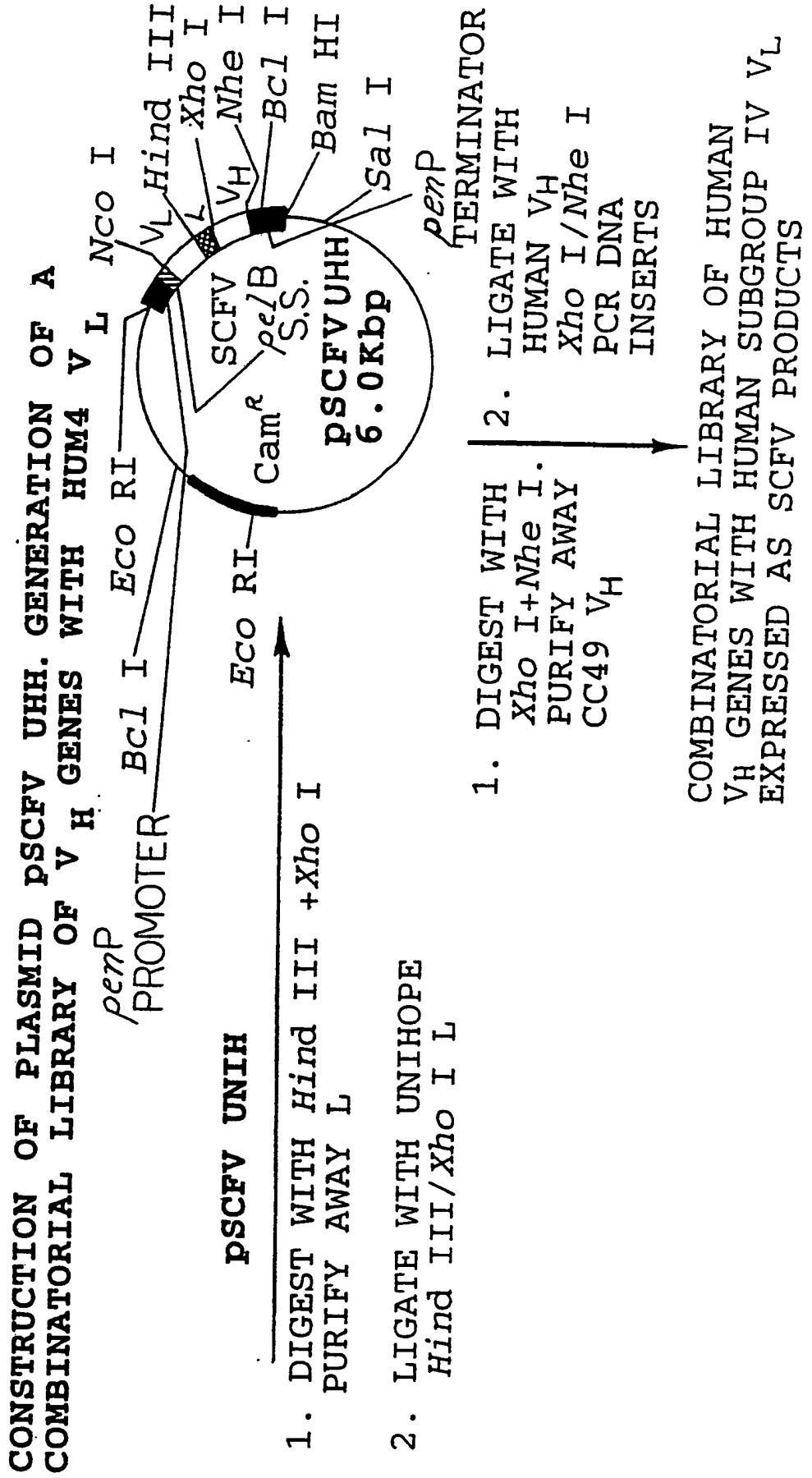

FIG. 28

Eco RI

CTCATGTTTG ACAGCTTATC ATCGATGAAT
TCCATCACTT CCCTCCGTTT AATTGTCCCC
GGTGGAAACG AGGTCATCAT TTCCTTCCGA
AAAAACGGTT GCATTTAAAT CTTACATATG
TAATACTTTC AAAGACTACA TTTGTAAGAT
TTGATGTTTG AGTCGGCTGA AAGATCGTAC
GTACCAATTA TTGTTTCGTG ATTGTTCAAG
CCATAACACT GTAGGGATAG TGGAAAGAGT
GCTTCATCTG GTTACGATCA ATCAAATATT

← **pelB Signal**
Met Lys Tyr Leu
CAAACGGAGG GAGACGATTT TG | ATG AAA TAC CTA

Sequence

Leu Pro Thr Ala Ala Ala Gly Leu Leu Leu
TTG CCT ACG GCA GCC GCT GGA TTG TTA TTA

Nco I → ← **H4V_L**

Leu Ala Ala Gln Pro Ala Met Ala | Asp Ile
CTC GCT GCC CAA CCA GCC ATG GCC | GAC ATC

Val Met Thr Gln Ser Pro Asp Ser Leu Ala
GTG ATG ACC CAG TCT CCA GAC TCC CTG GCT

Val Ser Leu Gly Glu Arg Ala Thr Ile Asn
GTG TCT CTG GGC GAG AGG GCC ACC ATC AAC

Cys Lys Ser Ser Gln Ser Val Leu Tyr Ser
TGC AAG TCC AGC CAG AGT GTT TTA TAC AGC

FIG. 28 (CONT.)

Ser Asn Asn Lys Asn Tyr Leu Ala Trp Tyr
TCC AAC AAT AAG AAC TAC TTA GCT TGG TAC

Gln Gln Lys Pro Gly Gln Pro Pro Lys Leu
CAG CAG AAA CCA GGA CAG CCT CCT AAG CTG

Leu Ile Tyr Trp Ala Ser Thr Arg Glu Ser
CTC ATT TAC TGG GCA TCT ACC CGG GAA TCC

Gly Val Pro Asp Arg Phe Ser Gly Ser Gly
GGG GTC CCT GAC CGA TTC AGT GGC AGC GGG

Ser Gly Thr Asp Phe Thr Leu Thr Ile Ser
TCT GGG ACA GAT TTC ACT CTC ACC ATC AGC

Ser Leu Gln Ala Glu Asp Val Ala Val Tyr
AGC CTG CAG GCT GAA GAT GTG GCA GTT TAT

Tyr Cys Gln Gln Tyr Tyr Ser Tyr Pro Leu
TAC TGT CAG CAA TAT TAT AGT TAT CCT CTC

Thr Phe Gly Gly Gly Thr Lys Val Val Ile
ACT TTC GGC GGA GGG ACC AAG GTG GTG ATC

Hind III LINKER

Lys | Leu Ser Ala Asp Asp Ala Lys Lys Asp
AAG | CTT AGT GCG GAC GAT GCG AAA AAG GAT

Ala Ala Lys Lys Asp Asp Ala Lys Lys Asp
GCT GCG AAG AAG GAT GAC GCT AAG AAA GAC

LINKER **Xho** I

Asp Ala Lys Lys Asp Leu | Glu
GAT GCT AAA AAG GAC CTC | GAG

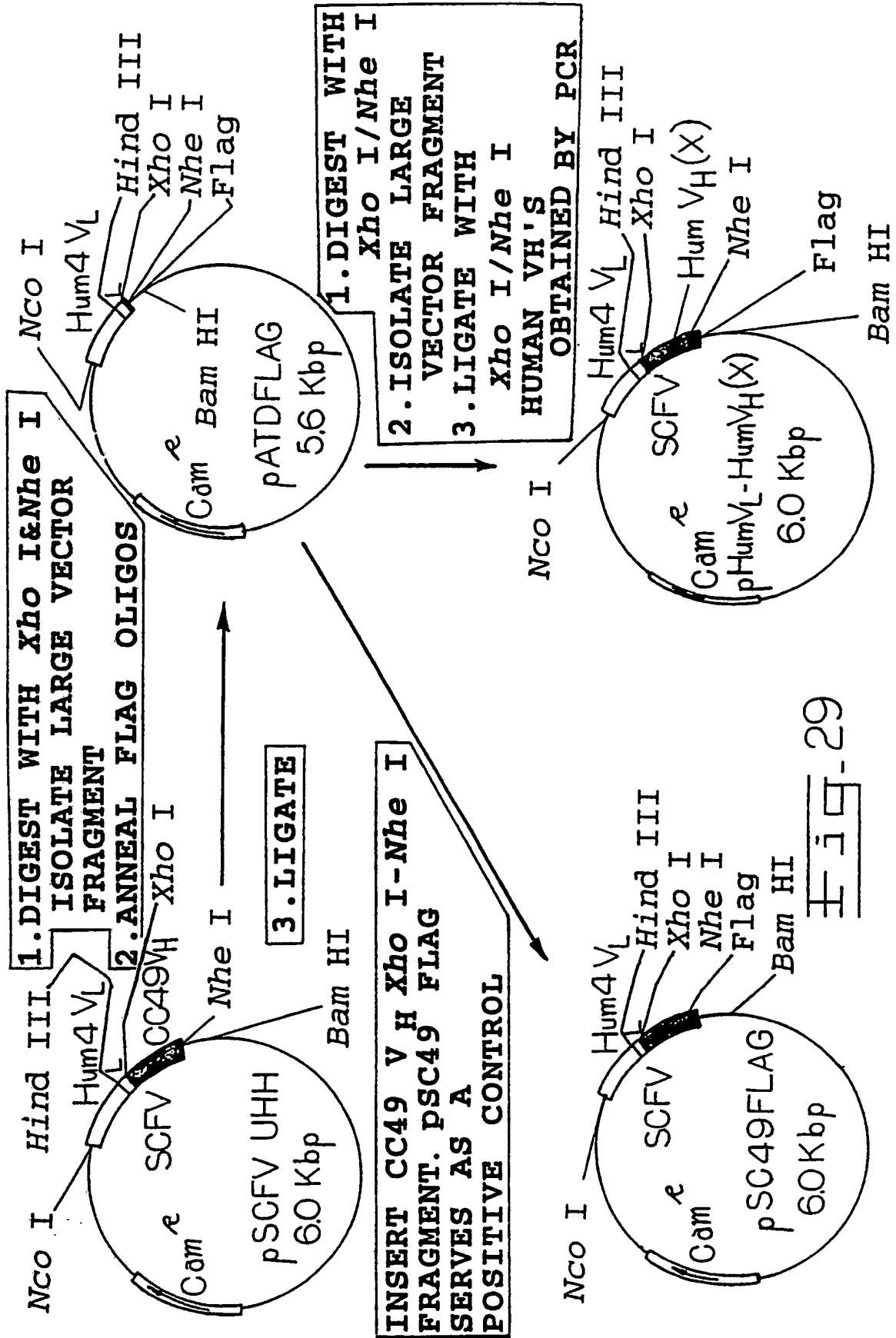

Fig. 29

FIG. 30

Eco RI

CTCATGTTTG ACAGCTTATC ATCGATGAAT
 TCCATCACTT CCCTCCGTTT AATTGTCCCC
 GGTGGAAACG AGGTCATCAT TTCCTTCCGA
 AAAAACGGTT GCATTTAAAT CTTACATATG
 TAATACTTTC AAAGACTACA TTTGTAAGAT
 TTGATGTTTG AGTCGGCTGA AAGATCGTAC
 GTACCAATTA TTGTTTCGTG AATTGTTCAAG
 CCATAACACT GTAGGGATAG TGGAAAGAGT
 GCTTCATCTG GTTACGATCA ATCAAATATT

CAAACGGAGG GAGACGATTT TG | *pe1B* Signal
 Met Lys Tyr Leu
 ATG AAA TAC CTA

Sequence

Leu Pro Thr Ala Ala Ala Gly Leu Leu Leu
 TTG CCT ACG GCA GCC GCT GGA TTG TTA TTA

Nco I → | ← *H4V_L*

Leu Ala Ala Gln Pro Ala Met Ala Asp Ile
 CTC GCT GCC CAA CCA GCC ATG GCC GAC ATC

Val Met Thr Gln Ser Pro Asp Ser Leu Ala
 GTG ATG ACC CAG TCT CCA GAC TCC CTG GCT

Val Ser Leu Gly Glu Arg Ala Thr Ile Asn
 GTG TCT CTG GGC GAG AGG GCC ACC ATC AAC

Cys Lys Ser Ser Gln Ser Val Leu Tyr Ser
 TGC AAG TCC AGC CAG AGT GTT TTA TAC AGC

FIG. 30 (CONT.)

Ser Asn Asn Lys Asn Tyr Leu Ala Trp Tyr
TCC AAC AAT AAG AAC TAC TTA GCT TGG TAC

Gln Gln Lys Pro Gly Gln Pro Pro Lys Leu
CAG CAG AAA CCA GGA CAG CCT CCT AAG CTG

Leu Ile Tyr Trp Ala Ser Thr Arg Glu Ser
CTC ATT TAC TGG GCA TCT ACC CGG GAA TCC

Gly Val Pro Asp Arg Phe Ser Gly Ser Gly
GGG GTC CCT GAC CGA TTC AGT GGC AGC GGG

Ser Gly Thr Asp Phe Thr Leu Thr Ile Ser
TCT GGG ACA GAT TTC ACT CTC ACC ATC AGC

Ser Leu Gln Ala Glu Asp Val Ala Val Tyr
AGC CTG CAG GCT GAA GAT GTG GCA GTT TAT

Tyr Cys Gln Gln Tyr Tyr Ser Tyr Pro Leu
TAC TGT CAG CAA TAT TAT AGT TAT CCT CTC

Thr Phe Gly Gly Gly Thr Lys Val Val Ile
ACT TTC GGC GGA GGG ACC AAG GTG GTG ATC

Hind III LINKER

Lys | Leu Ser Ala Asp Asp Ala Lys Lys Asp
AAG | CTT AGT GCG GAC GAT GCG AAA AAG GAT

Ala Ala Lys Lys Asp Asp Ala Lys Lys Asp
GCT GCG AAG AAG GAT GAC GCT AAG AAA GAC

LINKER **Xho** I CC49 V_H

Asp Ala Lys Lys Asp Leu | Glu Val Gln Leu
GAT GCT AAA AAG GAC CTC | GAG GTT CAG TTG

FIG. 30 (CONT.)

Gln	Gln	Ser	Ala	Glu	Leu	Val	Lys	Pro	Gly
CAG	CAG	TCT	GCT	GAG	TTG	GTG	AAA	CCT	GGG
Ala	Ser	Val	Lys	Ile	Ser	Cys	Lys	Ala	Ser
GCT	TCA	GTG	AAG	ATT	TCC	TGC	AAG	GCT	TCT
Gly	Tyr	Thr	Phe	Thr	Asp	His	Ala	Ile	His
GGC	TAC	ACC	TTC	ACT	GAC	CAT	GCA	ATT	CAC
Trp	Val	Lys	Gln	Asn	Pro	Glu	Gln	Gly	Leu
TGG	GTG	AAA	CAG	AAC	CCT	GAA	CAG	GGC	CTG
Glu	Trp	Ile	Gly	Tyr	Phe	Ser	Pro	Gly	Asn
GAA	TGG	ATT	GGA	TAT	TTT	TCT	CCC	GGA	AAT
Asp	Asp	Phe	Lys	Tyr	Asn	Glu	Arg	Phe	Lys
GAT	GAT	TTT	AAA	TAC	AAT	GAG	AGG	TTC	AAG
Gly	Lys	Ala	Thr	Leu	Thr	Ala	Asp	Lys	Ser
GGC	AAG	GCC	ACA	CTG	ACT	GCA	GAC	AAA	TCC
Ser	Ser	Thr	Ala	Tyr	Val	Gln	Leu	Asn	Ser
TCC	AGC	ACT	GCC	TAC	GTG	CAG	CTC	AAC	AGC
Leu	Thr	Ser	Glu	Asp	Ser	Ala	Val	Tyr	Phe
CTG	ACA	TCT	GAG	GAT	TCT	GCA	GTG	TAT	TTC
Cys	Thr	Arg	Ser	Leu	Asn	Met	Ala	Tyr	Trp
TGT	ACA	AGA	TCC	CTG	AAT	ATG	GCC	TAC	TGG
Gly	Gln	Gly	Thr	Ser	Val	Thr	Val	Ser	Ser
GGT	CAA	GGA	ACC	TCA	GTC	ACC	GTC	TCC	TCA

CC49 V_H →

INTERNATIONAL APPLICATION NO. PCT/AU 91/00583

This Annex lists the known "A" publication level patent family members relating to the patent documents cited in the above-mentioned international search report. The Australian Patent Office is in no way liable for these particulars which are merely given for the purpose of information.

Patent Document Cited in Search Report	Patent Family Member			
AU 89/43540	AU 44299/89 DK 1499/90 FI 903056 JP 3502889 ZA 8907858	BR 8907126 EP 365997 HU 896255 NO 902696	CA 2000913 EP 397821 IL 92037 WO 9004410	
AU 89/44299	AU 43540/89 DK 1499/90 FI 903056 IL 92037 WO 9004410	BR 8907126 EP 397821 HU 896255 JP 3502889 ZA 8907858	CA 2000913 EP 365997 HU 56878 NO 902696	

International Application No: PCT/ AU91 / 00583

MICROORGANISMS	
Optional Sheet in connection with the microorganism referred to on page <u>46</u> line <u>3</u> of the description ¹	
A. IDENTIFICATION OF DEPOSIT ¹	
Further deposits are identified on an additional sheet <input type="checkbox"/> ²	
Name of depositary institution ⁴ American Type Culture Collection	
Address of depositary institution (including postal code and country) ⁴ 12301 Parklawn Drive, Rockville, Maryland 20852 USA	
Date of deposit ⁴ April 18, 1990	Accession Number ⁴ ATCC HB 10426
B. ADDITIONAL INDICATIONS ¹ (leave blank if not applicable). This information is continued on a separate attached sheet <input type="checkbox"/>	
In respect of those designations in which a European patent is sought, a sample of the deposited microorganism will be made available until the publication of the mention of the grant of the European patent or until the date on which the application has been refused or withdrawn or is deemed to be withdrawn, only by the issue of such a sample to an expert nominated by the person requesting the sample (Rule 28(4) EPC)	
C. DESIGNATED STATES FOR WHICH INDICATIONS ARE MADE ¹ (If the indications are not for all designated States)	
The cell lines will be made available if a patent office signatory to the Budapest Treaty certifies one's right to receive, or if a United States Patent is issued citing the cell lines.	
D. SEPARATE FURNISHING OF INDICATIONS ¹ (leave blank if not applicable)	
The indications listed below will be submitted to the International Bureau later ¹ (Specify the general nature of the indications e.g. "Accession Number of Deposit"). In accordance with Regulation 3.25 of the Patents Regulations (Australia Statutory Rules 1991 No 71), samples of materials deposited in accordance with the Budapest Treaty in relation to an Australian Patent Request are only to be provided before: the patent is granted on the application; or the application has lapsed or been withdrawn or refused; to a person who is: a skilled addressee without an interest in the invention; and nominated by a person who makes a request for the furnishing of those samples.	
E. <input type="checkbox"/> This sheet was received with the international application when filed (to be checked by the receiving Office)	
_____ (Authorized Officer)	
<input checked="" type="checkbox"/> The date of receipt (from the applicant) by the International Bureau is ¹⁰	
27 JAN 1992	_____ (Authorized Officer)

International Application No: PCT/ AU91 / 00583

MICROORGANISMS	
Optional Sheet in connection with the microorganism referred to on page <u>46</u> , line <u>3</u> of the description *	
A. IDENTIFICATION OF DEPOSIT *	
Further deposits are identified on an additional sheet <input type="checkbox"/> *	
Name of depositary institution *	
American Type Culture Collection	
Address of depositary institution (including postal code and country) *	
12301 Parklawn Drive Rockville, Maryland 20852 USA	
Date of deposit *	Accession Number *
April 18, 1990	ATCC HB 10427
B. ADDITIONAL INDICATIONS * (leave blank if not applicable). This information is continued on a separate attached sheet <input type="checkbox"/>	
<p>In respect of those designations in which a European patent is sought, a sample of the deposited microorganism will be made available until the publication of the mention of the grant of the European patent or until the date on which the application has been refused or withdrawn or is deemed to be withdrawn, only by the issue of such a sample to an expert nominated by the person requesting the sample (Rule 28(4) EPC)</p>	
C. DESIGNATED STATES FOR WHICH INDICATIONS ARE MADE * (if the indications are not for all designated States)	
<p>The cell lines will be made available if a patent office signatory to the Budapest Treaty certifies one's right to receive, or if a United States Patent is issued citing the cell lines.</p>	
D. SEPARATE FURNISHING OF INDICATIONS * (leave blank if not applicable)	
<p>The indications listed below will be submitted to the International Bureau later * (Specify the general nature of the indications e.g. "Accession Number of Deposit")</p> <p>In accordance with Regulation 3.25 of the Patents Regulations (Australia Statutory Rules 1991 No 71), samples of materials deposited in accordance with the Budapest Treaty in relation to an Australian Patent Request are only to be provided before: the patent is granted on the application; or the application has lapsed or been withdrawn or refused; to a person who is: a skilled addressee without an interest in the invention; and nominated by a person who makes a request for the furnishing of those samples.</p>	
E. <input type="checkbox"/> This sheet was received with the international application when filed (to be checked by the receiving Office)	
_____ (Authorized Officer)	
<input checked="" type="checkbox"/> The date of receipt (from the applicant) by the International Bureau is	
27 JAN 1992	 _____ (Authorized Officer)

INTERNATIONAL SEARCH REPORT

I. CLASSIFICATION OF SUBJECT MATTER (if several classification symbols apply, indicate all) ⁶				
According to International Patent classification (IPC) or to both National Classification and IPC Int. Cl. ⁵ C12N 15/13, C12N 5/10, A61K 39/395, 47/48, 49/02, 43/00				
II. FIELDS SEARCHED				
Minimum Documentation Searched ⁷				
Classification System	Classification Symbols			
IPC	WPAT, Chemical Abstracts, Derwent Databases: Keywords: TAG 72 or (tumor or tumour) and associated and glyco:			
Documentation Searched other than Minimum Documentation to the Extent that such Documents are Included in the Fields Searched ⁸				
AU Search: C12N 15/13, C12P 21/08 Biotechnology Abstracts Derwent Database: Keywords: TAG 72 or (tumor or tumour) and associated and glyco:				
III. DOCUMENTS CONSIDERED TO BE RELEVANT ⁹				
Category [*]	Citation of Document, ¹¹ with indication, where appropriate of the relevant passages ¹²	Relevant to Claim No ¹³		
X	AU,A, 43540/89 (THE DOW CHEMICAL COMPANY) 26 April 1990 (26.04.90). See claims 1, 2, 5-9, 11-14, 16, 27, 29, 30, 32-35, 37-39	1-33		
X	AU,A, 44299/89 (THE DOW CHEMICAL COMPANY) 14 May 1990 (14.05.90). See claims 1, 7-11, 13-18, 29, 31-38, 48-50	1-3, 5-33		
Y	Whittle, N et al: 'Expression in COS cells of a mouse-human chimaeric B72.3 antibody'. Protein Engineering, volume 1, no. 6, pages 499-505, 1987	1, 6-9		
Y	Brady, R L et al.: "Crystallization and Preliminary X-ray Diffraction Study of a Chimaeric Fab' Fragment of Antibody (continued)	1, 6-9		
<table style="width: 100%; border: none;"> <tr> <td style="width: 50%; vertical-align: top;"> <p>[*] Special categories of cited documents : ¹⁰</p> <p>"A" Document defining the general state of the art which is not considered to be of particular relevance</p> <p>"E" earlier document but published on or after the international filing date</p> <p>"L" document which may throw doubts on priority claim(s) or which is cited to establish the publication date of another citation or other special reason (as specified)</p> <p>"O" document referring to an oral disclosure, use, exhibition or other means</p> <p>"P" document published prior t the international filing date but later than the priority date claimed</p> </td> <td style="width: 50%; vertical-align: top;"> <p>"T" Later document published after the international filing date or priority date and not in conflict with the application but cited to understand the principle or theory underlying the invention</p> <p>"X" document of particular relevance; the claimed invention cannot be considered novel or cannot be considered to involve an inventive step</p> <p>"Y" document of particular relevance; the claimed invention cannot be considered to involve an inventive step when the document is combined with one or more other such documents, such combination being obvious to a person skilled in the art</p> <p>"&" document member of the same patent family</p> </td> </tr> </table>			<p>[*] Special categories of cited documents : ¹⁰</p> <p>"A" Document defining the general state of the art which is not considered to be of particular relevance</p> <p>"E" earlier document but published on or after the international filing date</p> <p>"L" document which may throw doubts on priority claim(s) or which is cited to establish the publication date of another citation or other special reason (as specified)</p> <p>"O" document referring to an oral disclosure, use, exhibition or other means</p> <p>"P" document published prior t the international filing date but later than the priority date claimed</p>	<p>"T" Later document published after the international filing date or priority date and not in conflict with the application but cited to understand the principle or theory underlying the invention</p> <p>"X" document of particular relevance; the claimed invention cannot be considered novel or cannot be considered to involve an inventive step</p> <p>"Y" document of particular relevance; the claimed invention cannot be considered to involve an inventive step when the document is combined with one or more other such documents, such combination being obvious to a person skilled in the art</p> <p>"&" document member of the same patent family</p>
<p>[*] Special categories of cited documents : ¹⁰</p> <p>"A" Document defining the general state of the art which is not considered to be of particular relevance</p> <p>"E" earlier document but published on or after the international filing date</p> <p>"L" document which may throw doubts on priority claim(s) or which is cited to establish the publication date of another citation or other special reason (as specified)</p> <p>"O" document referring to an oral disclosure, use, exhibition or other means</p> <p>"P" document published prior t the international filing date but later than the priority date claimed</p>	<p>"T" Later document published after the international filing date or priority date and not in conflict with the application but cited to understand the principle or theory underlying the invention</p> <p>"X" document of particular relevance; the claimed invention cannot be considered novel or cannot be considered to involve an inventive step</p> <p>"Y" document of particular relevance; the claimed invention cannot be considered to involve an inventive step when the document is combined with one or more other such documents, such combination being obvious to a person skilled in the art</p> <p>"&" document member of the same patent family</p>			
IV. CERTIFICATION				
Date of the Actual Completion of the International Search 30 July 1992 (30.07.92)	Date of Mailing of this International Search Report 21 Aug 1992 (21.08.92)			
International Searching Authority AUSTRALIAN PATENT OFFICE	Signature of Authorized Officer K AYERS <i>Kara Ayers</i>			

FURTHER INFORMATION CONTINUED FROM THE SECOND SHEET

Binding Tumour Cells". J Mol Biol, 219, pages 603-604, 1991

V. OBSERVATIONS WHERE CERTAIN CLAIMS WERE FOUND UNSEARCHABLE ¹

This international search report has not been established in respect of certain claims under Article 17(2)(a) for the following reasons:

1. Claim numbers ..., because they relate to subject matter not required to be searched by this Authority, namely:

2. Claim numbers ..., because they relate to parts of the international application that do not comply with the prescribed requirements to such an extent that no meaningful international search can be carried out, specifically:

3. Claim numbers ..., because they are dependent claims and are not drafted in accordance with the second and third sentences of PCT Rule 6.4a

VI. OBSERVATIONS WHERE UNITY OF INVENTION IS LACKING ²

This International Searching Authority found multiple inventions in this international application as follows:

1. As all required additional search fees were timely paid by the applicant, this international search report covers all searchable claims of the international application.
2. As only some of the required additional search fees were timely paid by the applicant, this international search report covers only those claims of the international application for which fees were paid, specifically claims:

3. No required additional search fees were timely paid by the applicant. Consequently, this international search report is restricted to the invention first mentioned in the claims; it is covered by claim numbers:

4. As all searchable claims could be searched without effort justifying an additional fee, the International Searching Authority did not invite payment of any additional fee.

Remark on Protest

- The additional search fees were accompanied by applicant's protest.
- No protest accompanied the payment of additional search fees.

**This Page is Inserted by IFW Indexing and Scanning
Operations and is not part of the Official Record**

BEST AVAILABLE IMAGES

Defective images within this document are accurate representations of the original documents submitted by the applicant.

Defects in the images include but are not limited to the items checked:

- BLACK BORDERS
- IMAGE CUT OFF AT TOP, BOTTOM OR SIDES
- FADED TEXT OR DRAWING
- BLURRED OR ILLEGIBLE TEXT OR DRAWING
- SKEWED/SLANTED IMAGES
- COLOR OR BLACK AND WHITE PHOTOGRAPHS
- GRAY SCALE DOCUMENTS
- LINES OR MARKS ON ORIGINAL DOCUMENT
- REFERENCE(S) OR EXHIBIT(S) SUBMITTED ARE POOR QUALITY
- OTHER: _____

IMAGES ARE BEST AVAILABLE COPY.

As rescanning these documents will not correct the image problems checked, please do not report these problems to the IFW Image Problem Mailbox.